

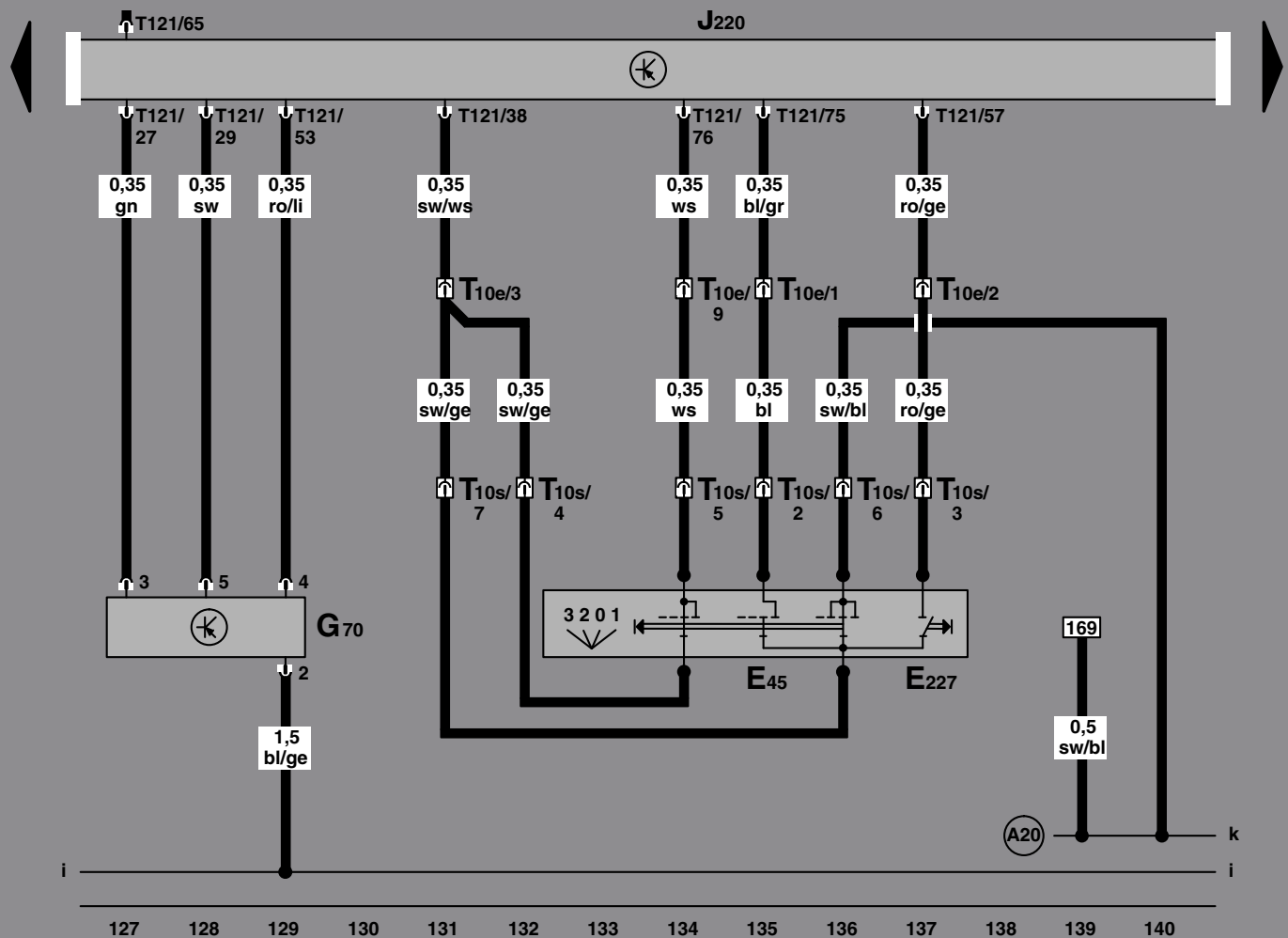

How to Read Wiring Diagrams

Symbols, Layout and Navigation



Volkswagen of America, Inc.
Service Training
Printed in U.S.A.
Printed 8/01
Course Number 873003

©2001 Volkswagen of America, Inc.

All rights reserved. Information contained in this manual is based on the latest information available at the time of printing and is subject to the copyright and other intellectual property rights of Volkswagen of America, Inc., its affiliated companies and its licensors. All rights are reserved to make changes at any time without notice. No part of this document may be reproduced, stored in a retrieval system, or transmitted in any form or by any means, electronic, mechanical, photocopying, recording or otherwise, nor may these materials be modified or reposted to other sites without the prior expressed written permission of the publisher.

All requests for permission to copy and redistribute information should be referred to Volkswagen of America, Inc.

Always check Technical Bulletins and the Volkswagen Worldwide Repair Information System for information that may supersede any information included in this booklet.

Table of Contents

	Page
Course goals	ii
Introduction	1
Wiring Diagram Overview	2
Layout	2
Navigation	3
Elements of a wiring diagram	4
Symbols	5
DIN 72 552	5
Introduction to Conductors	6
Wires	6
Wire colors	6
Wire sizes	6
Other Conductor descriptions	7
Connector Pin Assignments	9
Components	12
Layout	18
Practical Examples	21
Navigation 1	22
Navigation 2	24
Navigation 3	26
Navigation 4	29
Appendix A: Component Symbols	31
Appendix B: Wiring Connections	34
Appendix C: Component Codes and Wiring	35
Appendix D: DIN Standards	36
Appendix E: Wiring Diagrams	39
Glossary	77
Teletest	79

Course Goals

Course goals

This course will enable you to:

- Follow current from its power source to the Ground point quickly and accurately.
- Understand the symbols of common components and circuit designations used in Volkswagen Wiring Diagrams.
- Practice Wiring Diagram navigation through practical exercises and hands on examples.

Introduction

As today's vehicles become increasingly complex, so does the job of the technician. Wiring diagram navigation skills are critical to diagnosing and repairing today's vehicle in a timely and accurate manner.

This Self Study Program is not intended to instruct the technician how the electrical system operates in a vehicle. Given an understanding of electrical operation, this Self Study Program will introduce you to the skills necessary to read Volkswagen wiring diagrams.

In this program you will be exposed to all aspects of wiring diagrams, including:

- Commonly used symbols and their meanings
- Current tracks, including how to follow circuits between pages or diagrams
- Component identification
- DIN standards for terminal designations
- Wiring color codes and gauge (size)
- Terminal identification on both connectors and components

This book will provide examples of various types of circuits. The Computer Based Training (CBT) CD included at the end of this self study will provide an opportunity to practice "hands-on" wiring diagram navigation.

Areas of text that give the technician an opportunity to practice the concepts in the CBT will be designated with an icon of a CD (below) at the beginning of that section.



Wiring Diagram Overview

Overview

Volkswagen wiring diagrams are a graphic representation of the actual vehicle wiring. They are developed from the engineering drawings that are used to produce the wiring harness. A consistent set of symbols are used to represent the actual components and conductors.

Volkswagen electrical systems and wiring diagrams follow the German DIN (Deutsche Industrie Norm/Deutsches Institut für Normung) standards. These standards are guidelines for manufacturing in Germany, similar to SAE (Society of Automotive Engineers) in the United States.

Layout

The layout of wiring diagrams is common to all Volkswagen vehicles. Called “Current Track” wiring diagrams, they show the power source at the top of the page and the Ground points at the bottom. Situated vertically between power and Ground are the current tracks, which contain electrical components and conductors.

This current track layout simplifies the wiring diagram. Conductor symbols crossing where they do not connect is kept to a minimum. Refer to the example on page 3 for the basic layout of the wiring diagram.

Central/relay panel

The central/relay panel is indicated in gray at the top of the wiring diagram page. The central/relay panel includes common power circuits, such as battery power (30), ignition switched power (15), load reduction (75/X), and Ground (31).

Ground Connections

Ground connections are represented as a line at the bottom of the wiring diagram page, directly above the current track numbers. All Ground connections, whether they occur as a splice in a harness, or the final Ground source, are numbered and identified in the wiring diagram.

Conductors and components

Between the central/relay panel and the vehicle ground at the bottom of the diagram are located the component symbols and conductors. Components are marked with a component code listed in the legend. Conductors are generally marked with wire color and size.

Current tracks

Individual current tracks are identified numerically along the base of the wiring diagram. These numbers are used to find the continuation of a conductor. Where the system or circuit layout is complex, this continuation may be on the same page, or on a different page.

For example, the number 191 inside of the small box on page 3 indicates that the wire is continued on current track 191. Following straight down on the diagram, we see that this wire is on current track 5. If we were to navigate to current track 191, we would see the same color and size wire with a small box containing the number 5.

Legend

Below the current track numbers you’ll find a legend of the components (by component code) found in the specific diagram. This will often detail the location of a given component or connection.

Wiring Diagram Overview

Navigation

Navigation in the wiring diagram is based around the use of the current track numbers. You will generally start with the affected component and then follow the associated circuit from there, tracing Power, Ground, and signals that affect the component's operation.

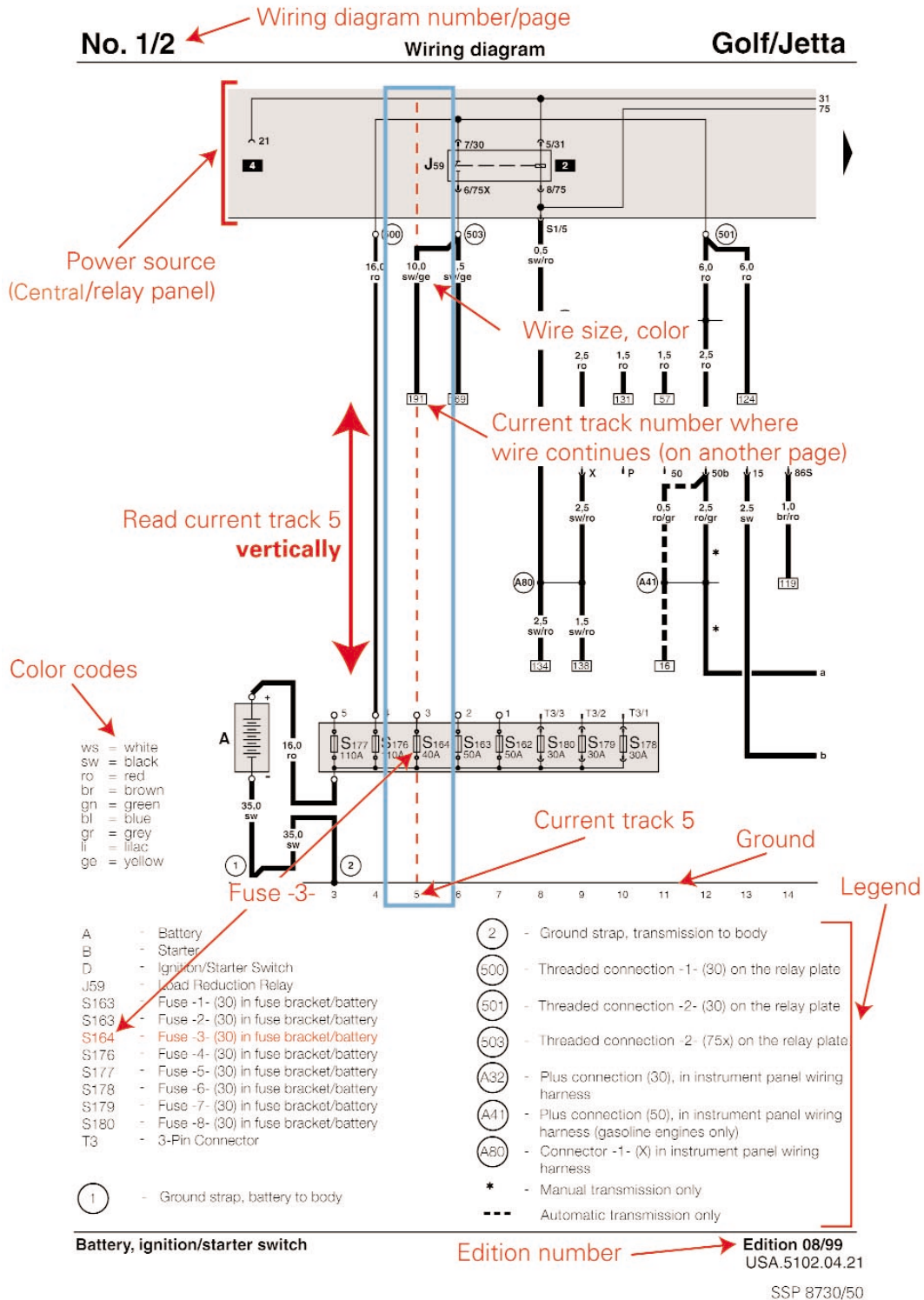

Elements of a Wiring Diagram

Elements of a wiring diagram

In this section, we will look at how various symbols are used in a wiring diagram to represent the actual components on the vehicle.

Every circuit needs a minimum of the following to operate:

- Power supply
- Consumer (load)
- Ground
- Conductors (usually wire)

If any of these are missing, a complete circuit is broken and the consumer will not function. The ability to break down a circuit into its individual parts is the key to being able to diagnose failures in the circuit.

Wiring diagrams incorporate many symbols used to illustrate a complete circuit. These symbols can include:

- Current track numbers
- Components
- Terminal designations
- Conductors
- Connectors

Together these components make up a complete and accurate wiring diagram.

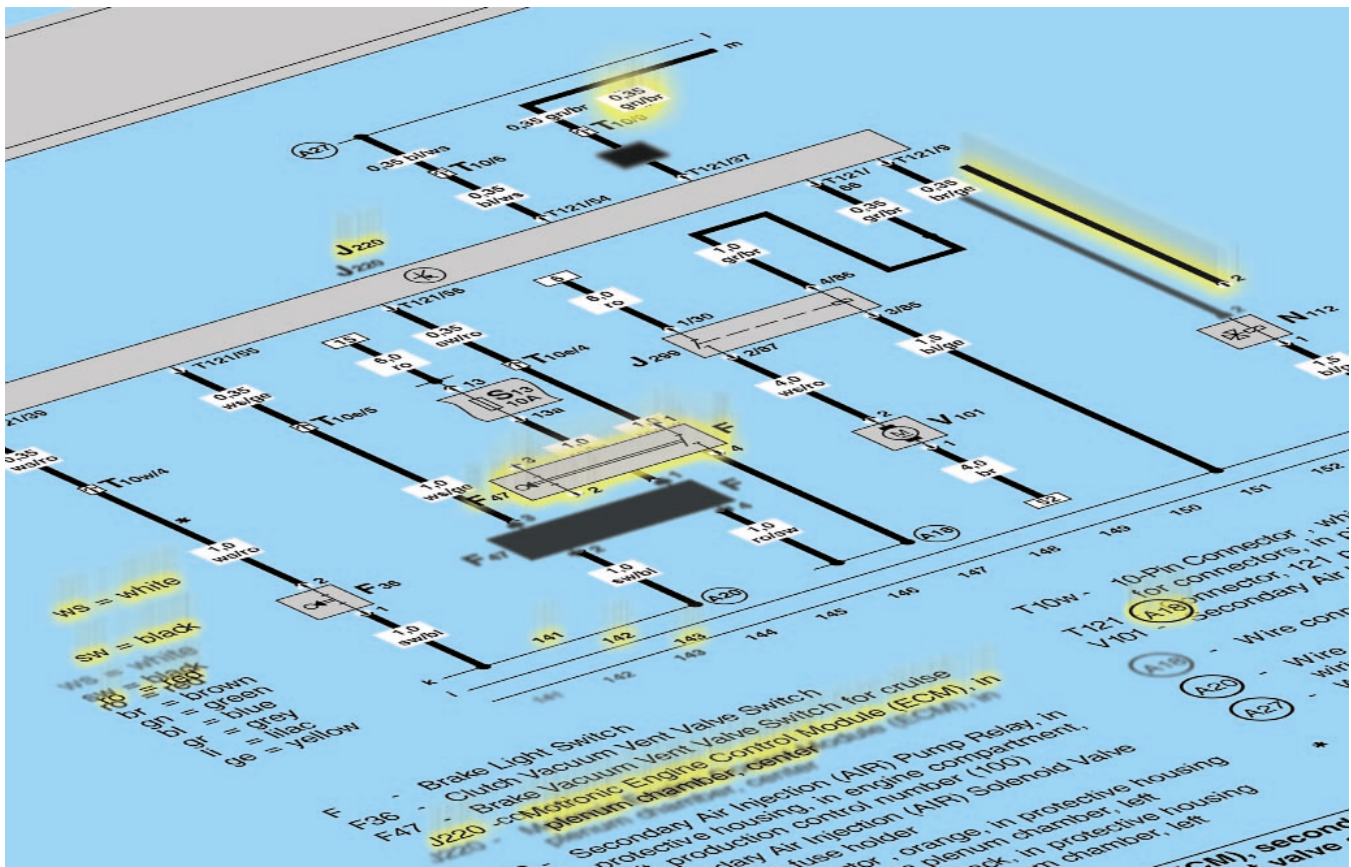

Symbols

Graphical representations called "symbols" are used to represent components and conductors in wiring diagrams. The key to reading wiring diagrams is understanding the symbols.

These symbols are standardized, allowing quick recognition of various components.

DIN Standard 72 552

This standard applies to the terminal designations for circuits. The purpose of the terminal designation system is to enable accurate connection identification from conductors (wires) to various components when diagnosis and repair is necessary. Examples of DIN standards for terminal designations are shown below:

1	Ignition coil primary
4	Ignition coil secondary
15	Ignition switched, on and start
30	Battery +
31	Ground
31b	Switched Ground
50	Starter control
75/X	Load Reduction/Ignition switched on only

The terminal designations do not identify the wires, but the type of circuit. For this reason, the designations are not placed on the wires in the diagram, but on the component. Refer to Appendix D on page 36 for a more complete list of terminal standards. Be aware that some abbreviations are used, and they may be abbreviations of German words. For example, "GRA" is the abbreviation for "cruise control," and VL is the abbreviation for "left front."

Elements of a Wiring Diagram

Introduction to Conductors

The wiring harness and related components may contain many different types of conductors, including wires, internal connections, threaded connections, welded connections, push-on connectors, multiple point connectors and Ground.

The complete list of wiring connections and symbols is shown in Appendix B.

Wires

Wires are conductors that carry current to components, and are usually indicated by a solid line. A wire shown as a dashed line in a wiring diagram indicates that the wire does not apply to all vehicles, and is noted in the wiring diagram legend.

Wire colors

Knowing the standards for wiring colors makes the job of reading and interpreting them easier. Some of the common standards include wiring color for specific circuits, as well as the terminal designation. For example:

Red	Battery +
Green.	Ignition (1)
Brown	Ground (31)
Yellow	Headlights (58)

Once the technician has an understanding of the color guides, the job of isolating systems becomes easier.

Wire colors are shown as abbreviations of the German word for the color.

The following list shows the German abbreviations to the English text for the most common colors. Refer to appendix C for other color code definitions.

bl	Blue
br	Brown
ge	Yellow
gn	Green
ro	Red
sw	Black
li	Violet
ws	White

Wire sizes

Wiring diagrams also indicate the wire gauge used (shown in mm²), designating the cross sectional area of the wire. Because standards exist for the maximum permissible voltage drop across a circuit, wire gauge is critical. If the voltage drop across the wire is too high, one or more of the following may occur:

- The circuit may overheat
- The consumer may not operate properly (due to low voltage condition)
- Components may be damaged

If a wiring repair needs to be made and metric sized wire is not available, the technician may need to use American Wire Gauge (AWG) sized wire.

Note:

- *If the exact size wire is not available for a repair, use the next larger size.*
- *For more information on wiring, refer to the **Wiring Harness Inspection and Repair** SSP (course number 871003).*

Elements of a Wiring Diagram

Other conductor descriptions

Internal conductors exist inside components, acting as bridges between the wiring harness and the final consumer. In some components these conductors are labeled in the component. An example would be the 30 circuit (Battery +) in the central/relay panel. In other components the conductor is not labeled. Internal conductors are shown as thin, black lines.

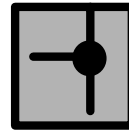

Physical contact

Some components, such as the starter or generator, may receive Ground where they are bolted to the engine or transmission. This is also shown as a thin black line.

Welded connections are used in wiring harnesses to join multiple, smaller gauge wires to a single larger wire which terminates at the fuse relay panel or chassis Ground.

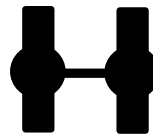

Sometimes a welded connection is shown with the thin line not terminating at another wire. This symbolizes that this welded connection is used in other diagrams for the car. The technician may need to reference other diagrams to locate components or Grounds related to this connection.

Threaded connectors are commonly used on the bottom of the fuse relay plate to distribute power and Ground to components. The common connectors include Battery power, Ground and load reduction (X).



Elements of a Wiring Diagram

Ground

The vehicle chassis acts as a common Ground conductor throughout the vehicle, and is identified by the line at the bottom of the wiring diagram above the current track numbers.

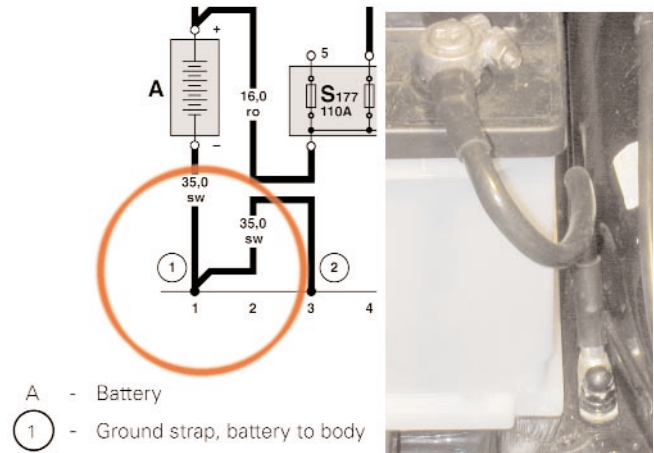

Some wiring diagrams will show ground designations at the bottom of the wiring diagram that are actually welded ground connections in the harness (see illustration SSP 8730/75). In practice, you may need to search through the legend to find where a welded ground connection finally attaches to the vehicle chassis.

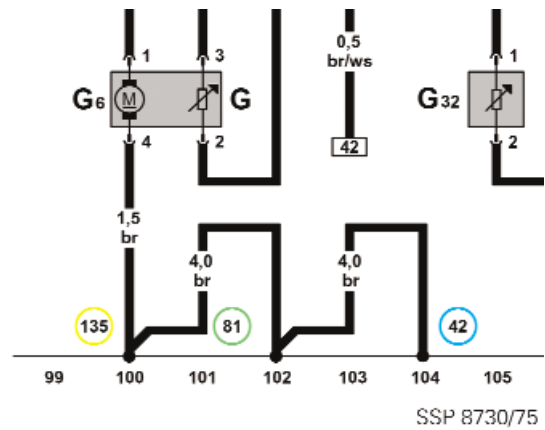

Other wiring diagrams will show welded Ground connections in the wiring harness, as shown in illustration SSP 8730/79.

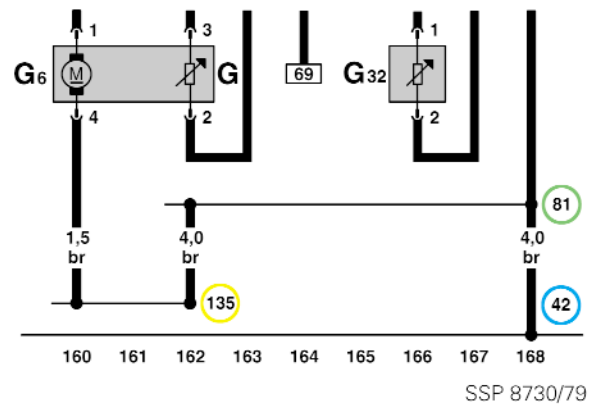

- 42 - Ground connection, beside steering column
- 81 - Ground connection -1-, in instrument panel wiring harness
- 135 - Ground connection -2-, in instrument panel wiring harness

Elements of a Wiring Diagram

Connector pin assignments

Wiring diagrams tell the user at which pin numbers the wires terminate, simplifying diagnosis.

There are 4 main types of terminal designations:

- Push-on/multi-point connections
- Component/multi-point
- Central/relay panel
- Relay

Push-on/multi-pin connectors use the "T" designation, and are identified in the legend. For example, T8a/5 designates an 8-pin connector, with the specified wire located in terminal 5 of the connector housing. The legend will give additional information about this connector. For example: "8-Pin connector, brown, in engine compartment, in wiring duct, left" (see Wiring Diagram example 41 beginning on page 61 for specific examples).

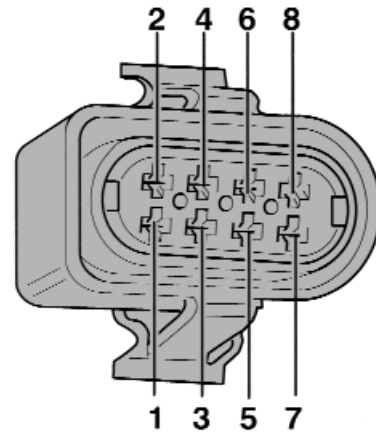

SSP 8/30/33

Generally, pin assignments are labeled on the plastic hard-shell connector housing and/or the corresponding component. On larger connectors, pin assignments are labeled at either end of a row. For example, the Engine Control Module (ECM) plug often has 2 or 3 rows of 12 or more terminals. Each row will be marked on each end to facilitate easier diagnosis.

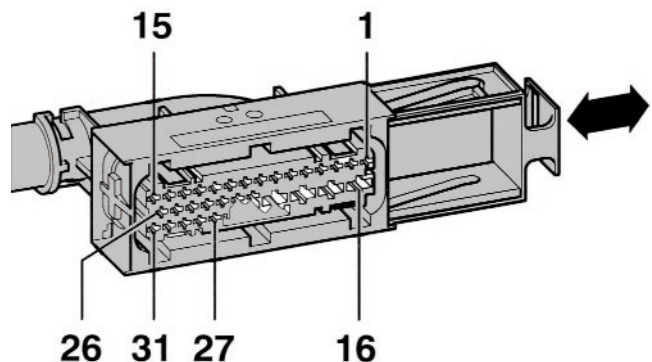

SSP 8730/48

Elements of a Wiring Diagram

Component/multi-point pin assignments may or may not use the "T" designation. Some are numbered sequentially. Others may use DIN circuit designations, or a combination of these methods. See example at right, and find two examples in wiring diagram 29 (Appendix E).

Central/relay panel connections enter or exit as either threaded connections, or multi-point connectors. Threaded connections are identified in the legend, and may be identified on the component with the DIN circuit designation.

Multi-point connectors on the back of the panel are not identified in the legend. They will have a letter and possibly a number to identify location, followed by the pin number. For example S1/5 would be connector S1, pin 5.

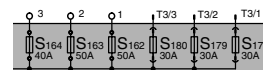
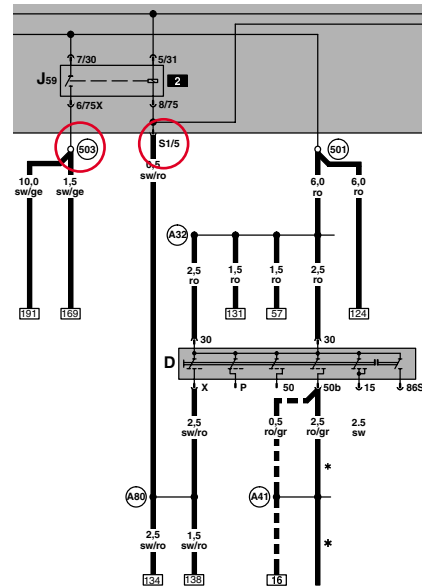
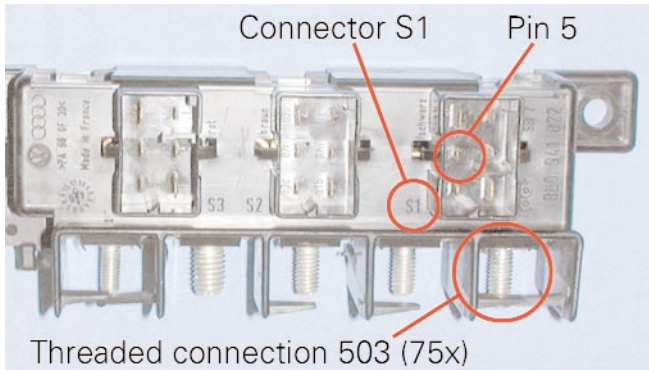
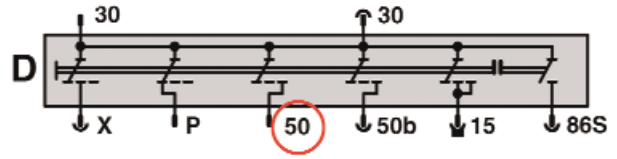

5 6 7 8 9 10 11 12 13 14
SSP 8730/55

Elements of a Wiring Diagram

Relay connections list the terminal cavity number on the relay socket, followed by the pin identification on the relay. Illustration SSP 8730/65 shows that cavity 2 of the harness connector is associated with the DIN terminal 30 of the relay. Both may be used during diagnosis of the circuit.

Note:

When diagnosing electrical concerns using the VAG 1598 pin-out box, the pin numbers on the control module and multi pin connector usually match the pin numbers on the tool.

*When using the VAG 1466 pin-out box, the numbers on the relay or control module and socket usually **do not** match those on the tool. These must be noted before beginning diagnosis.*

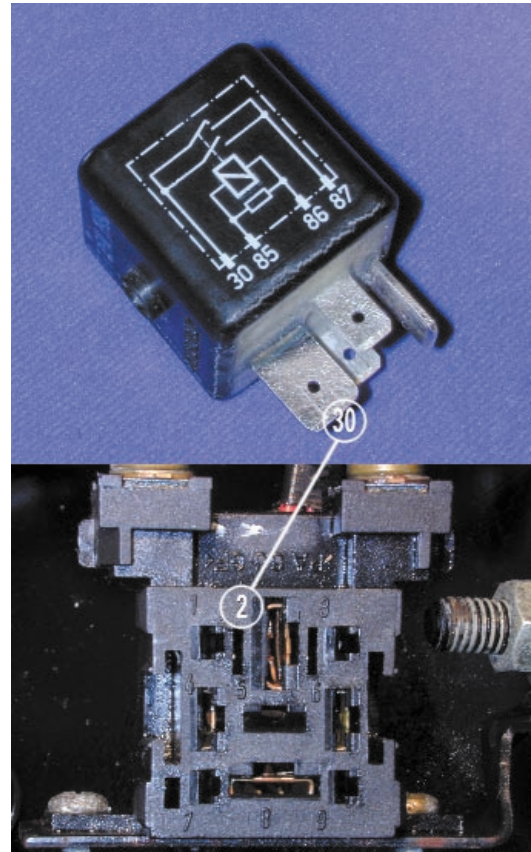

SSP 8730/65

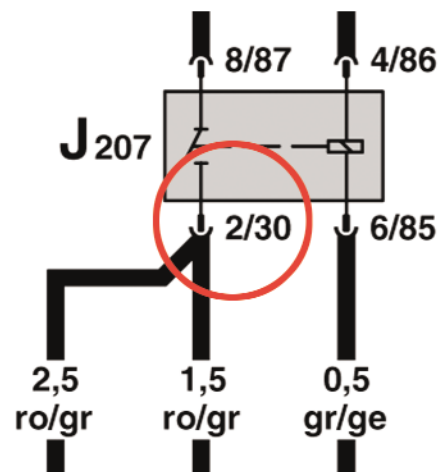

J207 - Starting Interlock Relay

SSP 8730/76

Elements of a Wiring Diagram

Components

Components in wiring diagrams are given an alphanumeric designation for identification. The first portion of the code separates the component into basic groups. An *F* for example, designates a switch, while a *Z* would be used for a heating element. A complete list of these designations are shown in Appendix C on page 43. The second part (numeric) designates which component is covered inside of these main groups.

Example: Evaporative Emissions (EVAP) Canister Purge Regulator Valve N80. N designates a solenoid valve, 80 clarifies which solenoid is being dealt with.



Resistor

A commonly used symbol is the **resistor**, used to create a voltage drop in a circuit. Below are three types of resistors:

A **standard resistor** has a fixed resistance.



SSP 8730/57

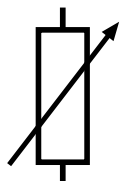

Variable Resistor (Rheostat)

A **rheostat**, or **potentiometer**, varies its resistance based on mechanical input. An example of this is the Throttle Position Sensor (TPS) on a Motronic equipped car (SSP 8730/57).



SSP 8730/56

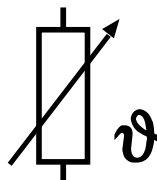

Temperature Dependent Resistor

A **temperature dependent resistor** varies its resistance based on temperature. This type of resistor is used as the Engine Coolant Temperature (ECT) sensor on an engine management system, or the Interior Temperature sensor on models with climate control (SSP 8730/56).

When a resistor is used as a sensor, it generally carries a component designator "G."



SSP 8730/21

Note:

Any time the temperature symbol (left) is attached to another symbol, it signifies that the operation of that component will vary with temperature.

Elements of a Wiring Diagram

The **switch** is another component used to control current flow. The basic symbols for an open and closed switch are shown in illustration SSP 8730/22. An example of this simple two-position switch would be a glove compartment light switch. A simple switch uses the component designation "F"

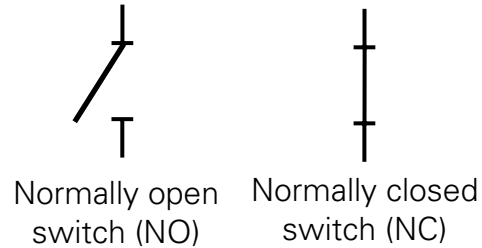

SSP 8730/22

There are many types of designs, including mechanically actuated, pressure actuated, temperature actuated and momentary. Examples include:

- Oil pressure switch (pressure actuated)
- Cooling fan thermo-switch (temperature actuated)
- Brake Switch -F- (mechanically operated)

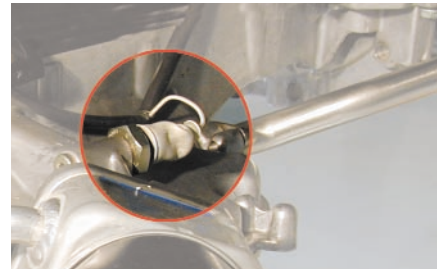

SSP 8730/60

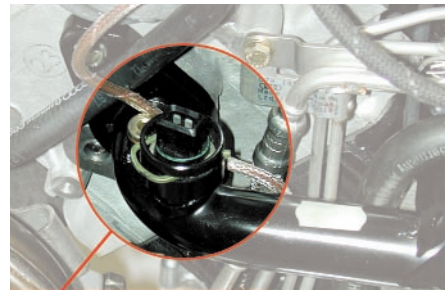

SSP 8730/59a

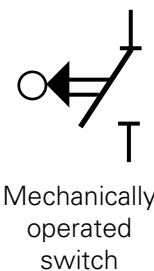

SSP 8730/58

More complex circuits may require a switch with multiple sets of contacts. An example of this would be the cruise control switch.

As you can see in illustration SSP 8730/25, there are multiple sets of contacts within the assembly. Depending on the position of the switch, various sets of contacts are open or closed. Careful study of the symbols allows the technician to follow the circuit through the switch under any condition.

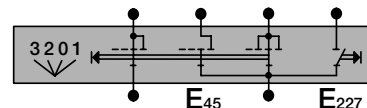

SSP 8730/25

A complex switch uses the component designation "E"

Note:
All switches and relays are shown in a non-operated state.

Elements of a Wiring Diagram

Fuses are used to prevent excessive current from damaging other components in a circuit. There are various types, including standard fuses, thermal fuses (circuit breakers), and strip fuses. Fuses use the component designation "S"; their symbols are shown below:

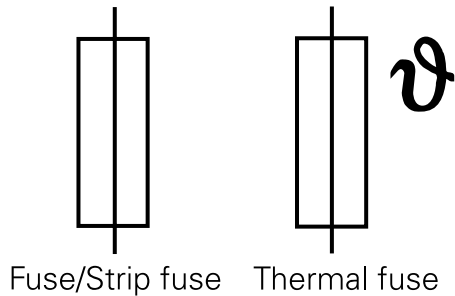

SSP 8730/23

The example below shows strip fuses and standard fuses as seen in a current model vehicle.

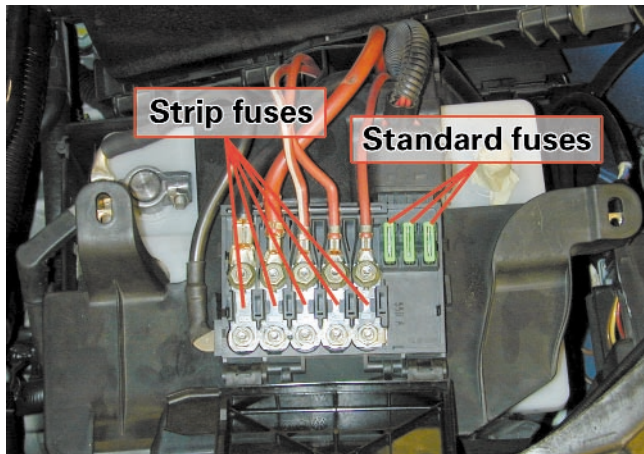

SSP 8730/45

Solenoids are used to actuate many different components, including fuel injectors and relays.

A solenoid is a coil of wire wrapped around an iron core. When current is passed through the wire, a magnetic field is induced. This pulls a set of contacts in the relay closed, either opening or closing the circuit.

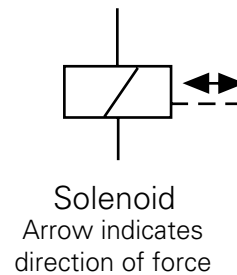

SSP 8730/24

Complex Symbols

Often the internal schematic of the component is shown to allow the technician to follow current flow through the component.

These internal symbols are a combination of several basic symbols. This allows the technician to take a more complex symbol and break it down into its smaller components. Even the most complex components are nothing more than a combination of smaller basic symbols.

More complex components may contain complex control circuitry. This will be indicated with the symbol of a transistor in the component symbol (see control module).

Elements of a Wiring Diagram

A **relay** is an example of a combination of symbols in a single component.

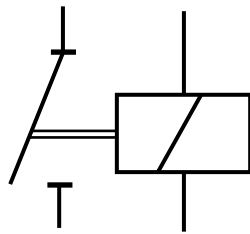

Relay

SSP 8730/26

Relays require a signal from an outside source to activate. Volkswagen vehicles use common Bosch®-type 4-pin relays on many circuits, to remove electrical load from the switch. Relays share the component designator "J" with control units.

The basic 4-pin relay (below) contains two separate components: a switch and a solenoid.

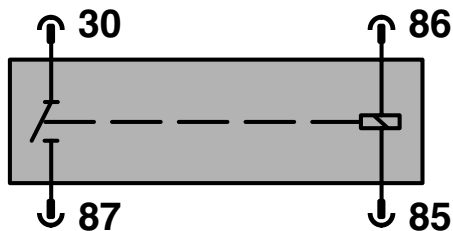

SSP 8730/49

The coil in the solenoid is energized with low current, creating a magnetic pull that closes or opens the switch.

Note:

All switches and relays are shown in a non-operated state.

The 4 pins of a standard relay are generally (but not always) numbered as follows:

- 30** Receives Battery power (switched to consumer)
- 87** High load to the electrical consumer
- 86** Ignition switch, Battery+, load reduction (X)
- 85** Receives a switched ground to activate the solenoid winding in the relay

Note:

A production number may appear on top of the relay (see illustration SSP 8730/61). This number may be referred to in the wiring diagram for diagnostic purposes. See page 45 for examples.

However, do not rely solely on this information when diagnosing a circuit, as this number may change in production. Always refer to the parts information system for the current replacement part numbers.

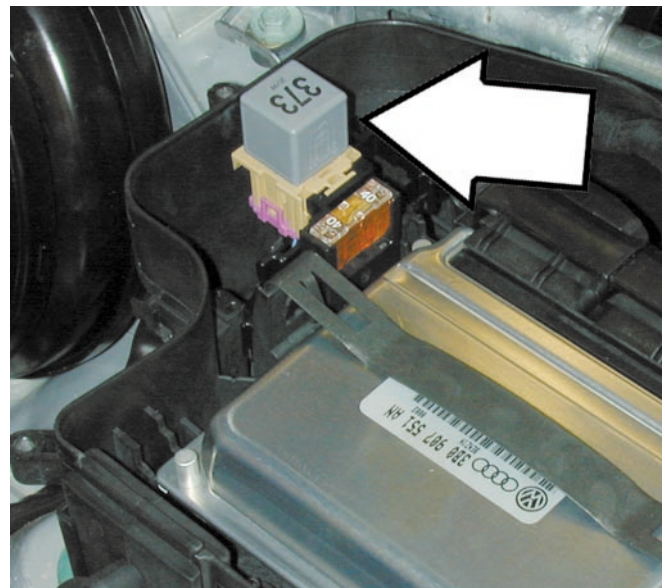

SSP 8730/61

Elements of a Wiring Diagram

The last of the more common symbols we will look at are the **Electric motor** and the **Electronic Control Module**.

Electric motors are used throughout the vehicle for numerous applications, including the Windshield Wiper Motor and the Fuel Pump.

At the top and bottom of the motor symbol there are dark squares, representing the brushes in the electric motor.



SSP 8730/62

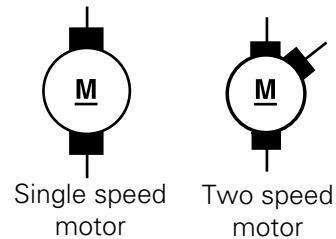

SSP 8730/28



SSP 8730/66

If there are only two brushes, it is a single speed motor. The rear window wiper motor shown in illustration SSP 8730/62 is an example of a single speed motor.

If there are three brushes, the motor has two speeds. In the case of the two speed motor, the upper set of brushes are the low and high speed brushes.

The windshield wiper motor shown in illustration SSP 8730/66 is an example of a two speed motor.

Elements of a Wiring Diagram

Control Modules can make the task of reading and interpreting wiring diagrams more difficult because multiple signals enter and/or exit, but the internal schematic is not always shown.

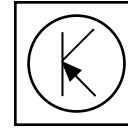

Control Module
SSP 8730/44

The Transmission Control Module (TCM) J217 seen in illustration SSP 8730/63 is an example of a common control module.

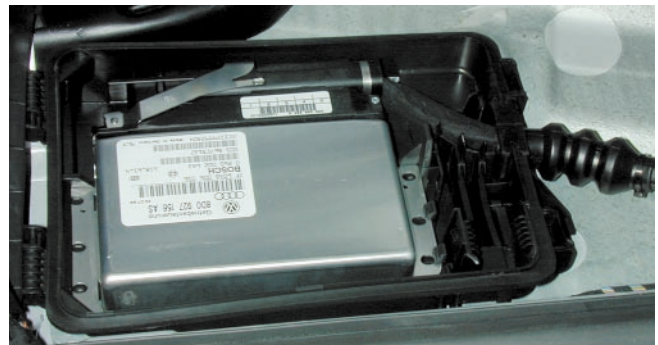

SSP 8730/63

Some control modules may be integrated with other components.

Take, for example, the window motor with control module. Both the motor and the control module are combined to make a single component (SSP 8730/74).

The symbol below represents the combined components.

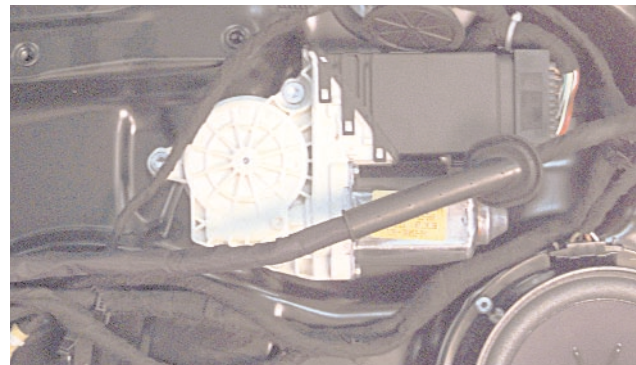

SSP 8730/74

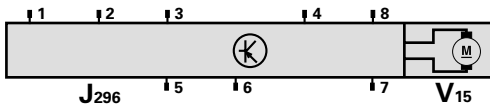

Elements of a Wiring Diagram

Layout

- 1. Relay location number**

Indicates location on relay panel. See page 1 of individual wiring diagram for details.
- 2. Arrow**

Indicates wiring circuit is continued on the previous and/or next page.
- 3. Connector designation - relay/control module on relay panel**

Shows relay panel terminals with corresponding relay terminal.
For example: 17/30 equals terminal 30 of relay connects to terminal 17 of central relay panel.
- 4. Threaded pin on relay panel**

White circle shows a threaded removable connection.
- 5. Fuse designation**

For example: S228 equals Fuse 28, 15 amps, in fuse holder.
- 6. Reference of wire continuation (current track number)**

Number in frame indicates current track where wire is continued (see page 3 for example).
- 7. Wire connection designation in wiring harness**

Location of wire connections are indicated in the legend.
- 8a. Terminal designation on a multipoint connector**
- 8b. Terminal designation on a component**

Designation which appears on the actual component and/or terminal number of a multi-point connector.
- 9. Ground connection designation in wire harness**

Locations of ground connections are indicated in legend.
- 10. Component designation**

Use legend at bottom of page to identify the component code.
- 11. Component symbols**

A graphical representation of a component type. See Appendix A, page 35.
- 12. Wire cross section size (in mm²) and wire colors**

Abbreviations are explained in the color chart beside the wiring diagram.
- 13. Component symbol with open drawing side**

Indicated component is continued on another wiring diagram. The number of the corresponding wiring diagram can be found in the table of contents.
- 14. Internal connections (thin lines)**

These connections are not wires. Internal connections are current carrying and are listed to allow tracing of current flow inside components and wiring harness.

 - a. Internal Harness Splice (Welded Connection)**
 - b. Physical Contact (Mounted to engine)**
- 15. Reference of continuation of wire to component (inset)**

For example: Control module for anti-theft immobilizer J362 on 6-pin connector terminal 2.
- 16. Central Relay panel connectors**

Shows wiring of multi-point or single connectors on central relay panel.
For example: S3/3 equals Multi-point connector S3, terminal 3.
- 17. Reference of internal connection continuation**

Letters indicate where connection continues on previous and/or next page.
- 18. Central Relay Panel**
- 19. Ground Path**

ex.: from welded harness connection 135 to welded harness connection 81 to welded harness connection 42.

Elements of a Wiring Diagram

Wiring Diagram Number and Page

New Beetle

Wiring diagram

No. 19/9

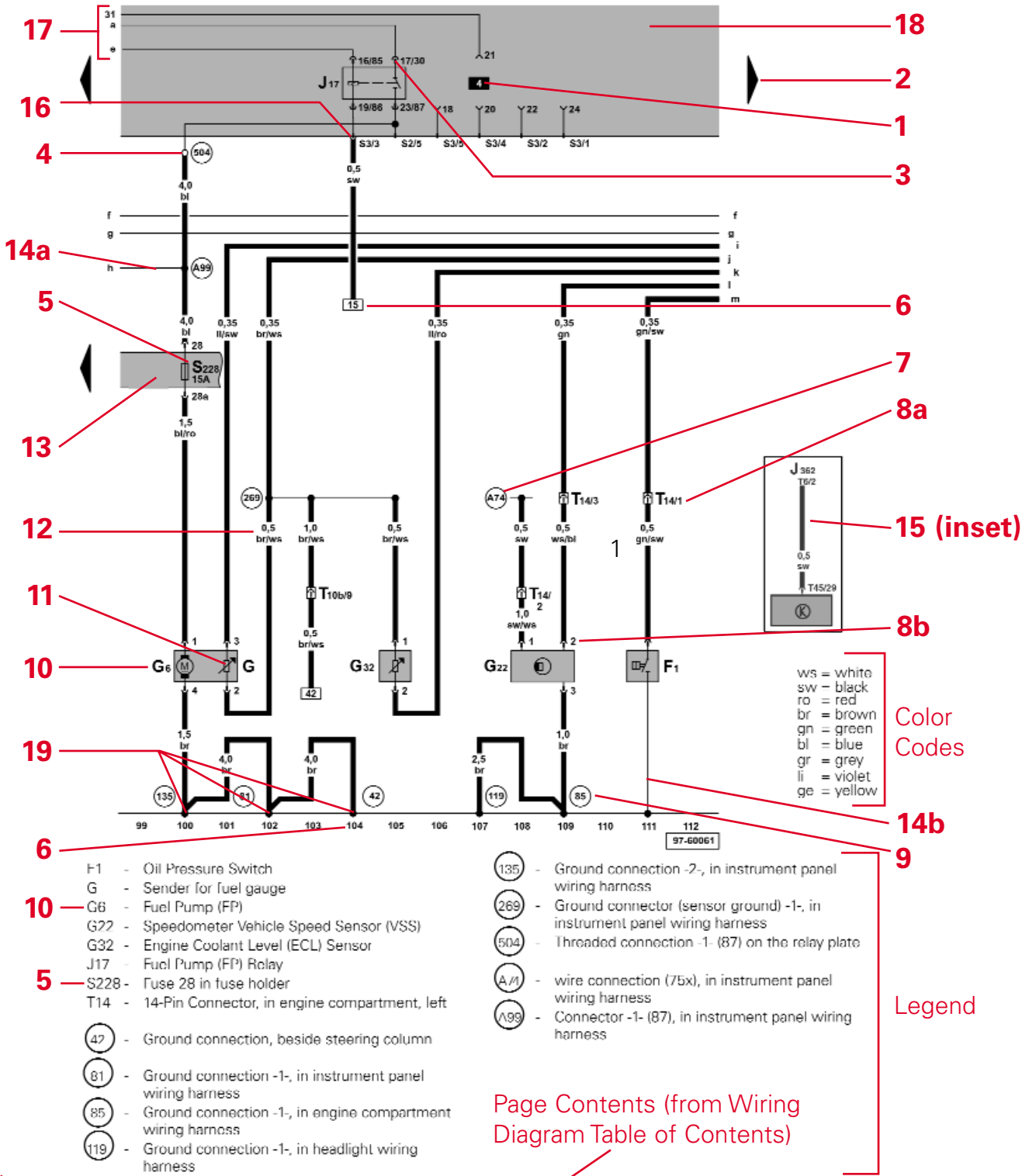

Edition number

Edition 09/98
USA.5132.05.21

Oil pressure switch, fuel pump (FP), fuel pump (FP) relay, engine coolant level sensor, speedometer vehicle speed sensor (VSS)

Working With Wiring Diagrams

Working with wiring diagrams

When working to diagnose electrical concerns on vehicles, it is important that you have the correct wiring diagram. Not only are there different models and year, wiring harnesses will often change in the middle of a model year. There may be differences between models of the same type and year, but built in different factories.

Within models, there are also different levels of equipment. For example, the wiring for the fresh air blower of a vehicle with Climatronic will be different from one without Climatronic. Different engines, transmissions, even trim levels will mean differences. Always check that the wiring diagram is right for the vehicle in question.

It may be necessary to check more than one wiring diagram for the model you are servicing. A vehicle's wiring harness is often split into several different wiring diagrams. Engine, transmission and power accessory wiring diagrams will only show wiring for those specific systems.

When choosing a wiring diagram for diagnosis of an electrical concern, you should first confirm the vehicle model, model year, and production date, where applicable. Next, identify if the affected system is part of vehicle "standard equipment" or "additional equipment". Locate the appropriate wiring diagram by using the index.

A standard equipment diagram will show the vehicle with its base level wiring. Base level wiring is defined as the most basic possible rolling chassis, and this may be different than what is normally considered "standard equipment".

For example, all 2001 m.y. Golfs and Jettas sold in the US and Canada come with Daytime Running Lamps as "standard equipment". However, the Daytime Running Lamps are shown in a separate wiring diagram.

Wiring diagrams are automatically shipped to your dealer. Periodic updates can include both new wiring diagrams and updated pages for existing diagrams.

Wiring diagrams also exist as part of the Volkswagen Electronic Service Information System (VESIS). The advantages of electronic wiring diagrams include easy updating, pages that don't get dirty or lost, and search capabilities that can make searching for a component much easier.

Practical Examples

The preceding sections of this book gave examples of the symbols and layout of our current track wiring diagrams. In the following section we will examine current flow using navigation exercises. In these examples, we will look at:

- how battery power is provided to a component
- how consumers are actuated using relays
- how to split up a circuit to simplify diagnosis
- the importance of looking in multiple wiring diagrams

Appendix E, starting on page 39, contains the complete wiring diagrams number 29 and 41. Within the navigation exercises, magnified views of specific sections of these Wiring Diagrams may be shown. Note that, for clarification purposes, certain components found in the Wiring Diagrams may not be shown in these magnifications.

Navigation 1



Navigation 1

In this example we will look at the circuit for the load reduction relay. The following page contains the complete diagram for this example.

The Load Reduction circuit supplies power to consumers such as the windshield wiper motor and fresh air blower motor when the ignition switch is in the "ON" position. With the ignition switch in the "START" position, the circuit is de-energized. This lowers the load on the electrical system when starting the vehicle.

Locate the Load Reduction Relay J59 on the wiring diagram on page 23. The relay consists of two separate circuits: the solenoid circuit, and the switch circuit. In order to supply power to the consumers in the load reduction circuit, the solenoid in the relay must be energized. To do this, terminal 8/75 must be supplied with power. The ground side of the solenoid receives an internal ground from the central relay panel at pin 5/31.

Starting at the Positive (+) terminal of the Battery (A), follow battery power (30) to the fuse box through a 16.0 ro wire.

Power then passes through S176, a 110A fuse, and exits the fuse box at terminal 4. From terminal 4, follow the 16.0 ro wire to threaded connection 500 on the central relay panel.

Power passes through the central relay panel and exits at threaded connection 501. From the relay plate, follow the 6.0 ro wire to welded connection A32 in the instrument panel wiring harness.

Note that the wire that supplies the power to the welded connection is larger than other wires that leave the connection. This fact can be useful in diagnosis. When tracing out a weld with many wire connections, the largest wire will usually be the one that goes directly to power or ground.

From the welded connection, a 2.5 ro wire goes to terminal 30 of the Ignition/Starter switch D. When the Ignition switch is moved to the "ON" position, power continues through the switch to the X contact. Power exits the Ignition switch through the 2.5 sw/ro wire on current track 9.

Follow the wire to welded connection A80. Another similar wire leaves this welded connection on current track 8, which connects to the central relay panel at terminal S1/5. Power flows from this terminal through the internal connection to terminal 8/75 of the relay.

Because relay terminal 5/31 is already grounded at the central relay panel, the solenoid is energized. This closes the switch and supplies power from terminal 500 (30), to terminal 503 (75/X) on the relay panel. From terminal 503, power can flow to the consumers on the circuit as needed.

No. 1/2

Wiring diagram

Golf/Jetta

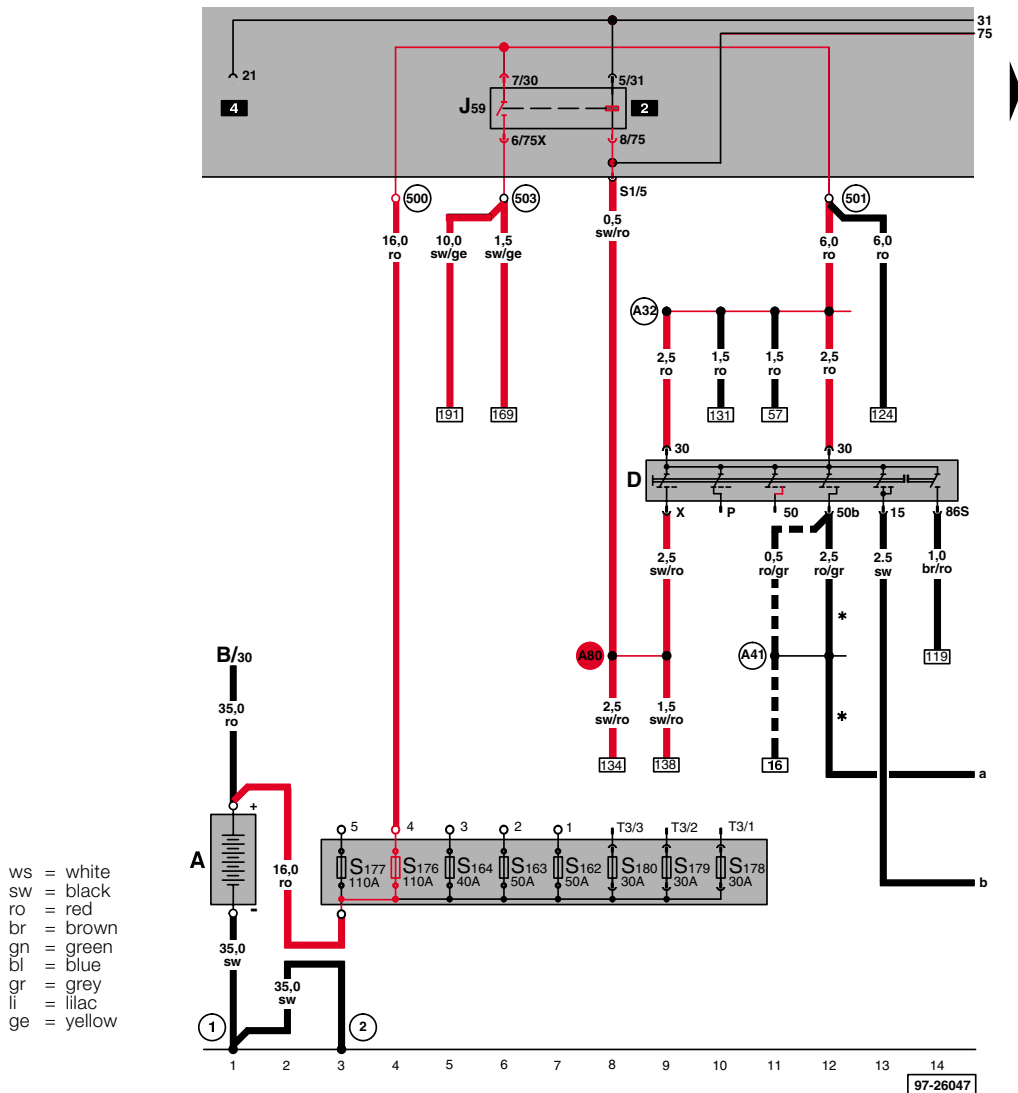

- A - Battery
- B - Starter
- D - Ignition/Starter Switch
- J59 - Load Reduction Relay
- S163 - Fuse -1- (30) in fuse bracket/battery
- S163 - Fuse -2- (30) in fuse bracket/battery
- S164 - Fuse -3- (30) in fuse bracket/battery
- S176 - Fuse -4- (30) in fuse bracket/battery
- S177 - Fuse -5- (30) in fuse bracket/battery
- S178 - Fuse -6- (30) in fuse bracket/battery
- S179 - Fuse -7- (30) in fuse bracket/battery
- S180 - Fuse -8- (30) in fuse bracket/battery
- T3 - 3-Pin Connector

Battery, ignition/starter switch

Edition 08/99
 USA.5102.04.21

Navigation 2



Navigation 2

This example will follow the flow of power from its source, through a switch, and to a consumer. This example will build on our understanding of the Load Reduction circuit as seen in Navigation example 1.

The example we will use is a typical horn circuit. The horn circuit on all Volkswagen vehicles is similar in design. The main components of the system are as follows.

- Mechanically operated switch (horn button)
- Relay
- Horns (high and low tone)
- Connecting wires

In order to follow these types of circuits, it is best to split the circuit into two sections. We will first look at the solenoid side of the relay circuit, then the switch side.

Note:

Refer to wiring diagram 29 in appendix E for this example.

From the table of contents for wiring diagram 29 (page 39), we see that the horn circuit is shown on page 29/15.

Locate the horn relay (J4) on page 29/15. Starting at the solenoid side of the symbol, follow the internal connection from terminal 4/75 across the central relay panel until it terminates at an internal connection that runs between terminal S1/5 on the back of the central relay panel, and terminal 8/75 of relay J59 on wiring diagram page 29/2. Looking at the legend, we see that J59 is the Load reduction relay.

Looking at the wiring for J59 we see that the internal connection we are concerned with here is the power that activates the load reduction relay. Follow the 0.5 sw/ro wire down current track 8 to plus connection A80, across to current track 9 and up to terminal X of component D.

We can see that power will flow from the battery, through fuse S176, and through the ignition switch to the horn relay when the ignition switch is in the on position. Now, back on page 29/15, let's take a look at the ground side of the Horn relay solenoid.

From J4, follow the ground side of the circuit from terminal 1/71 of the relay to S1/6. A 0.35 br/bl wire runs from the central relay panel to T5b/3. The legend identifies T5b as a 5 pin connector on the airbag spiral spring (F138).

From the spiral spring, the circuit continues through another 5 pin connector, T5j, through manually operated push button switch H (the horn contact), and then back through the spiral spring to T5b/2. From this terminal a 0.35 br wire runs to welded ground connection 135, in the instrument panel wiring harness.

Looking at 135, we see no less than 9 wires in the weld! In practice, you may need to trace out every wire in the weld to find a problem. Let's use the trick we discussed in the last example to narrow down the field. Looking at the left side of connection 135, we see a 4.0 br wire connecting to another internal connection, marked with the continuation "o."

Follow "o" in both directions. It is identified as welded ground connection 81, in the instrument wiring harness. It is connected to ground at two points; ground 49 at current track 182, and ground 42 at current track 201. We now have the complete circuit for the solenoid side of the relay.

Let's look at the horns and the switch circuit of the relay. Follow the internal connection "m" from terminal 3/30 at the relay to the fuse box at current track 153. Continue to follow the source of the power through the fuse and the current track continuation back to page two of the wiring diagram.

As seen in Navigation example 1, the power comes from the battery, through fuse S176, to threaded connection 500. From there it runs through the central relay panel to threaded connection 501, to the fuse box at fuse 40 (S240), and to the relay through the central relay panel. When the relay is activated by pushing the horn contact, power will flow to the horns through S2/2, through welded connection A90, to terminal 2 on each horn.

Tracing the ground side of the horns, we see that they jump to current tracks 74 and 75 from tracks 183 and 185, respectively. Going to current tracks 74 and 75, follow the brown wires to internal connection marked "d". We follow that along to find that it is welded connection 179, which goes to Ground through a 4.0 br wire at ground connection 12, in engine compartment left, shown on current track 61. We now have the complete circuit for the horns.

Navigation 3



Navigation 3

In this exercise, we will again examine the activation of an electrical consumer through a simple 4-pin relay. Let's look at the navigation from the point of view of diagnosing an inoperative motor. In this circuit we will look at the Secondary Air Injection (AIR) pump motor V101.

To diagnose this circuit, we need to understand that the secondary air system is activated by the Motronic ECM at certain times when the engine is running, and that we can trigger this function using the VAS 5051 scan tool. Assume that we have already attempted this, and the pump does not run. Also assume that the only DTC in the systems memory is the Secondary Air DTC.

Note:

Refer to the illustrations on pages 26-28 and wiring diagram 41 in appendix E for this example.

From the table of contents for wiring diagram 41 (page 40), we see that the Secondary Air circuit is shown on page 41/12.

Locate the Secondary Air Injection (AIR) pump relay J299 on wiring diagram page 41/12. We will once again split the circuit into two parts to simplify diagnosis. Let's start with the switch side of the relay.

From motor V101, follow the 4.0 br wire down to the current track continuation (illustration SSP8730/11), and over to page 41/5. The wire goes directly to Ground 609 in the right side of the plenum chamber. Now let's trace the power side.

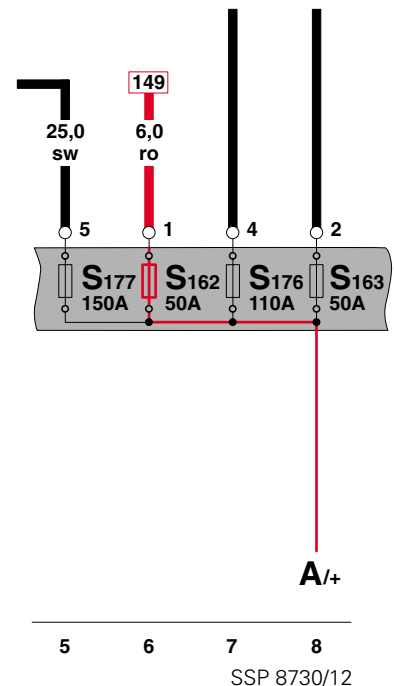
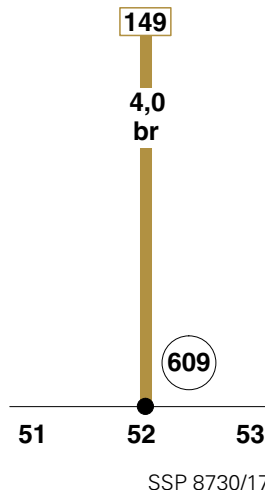
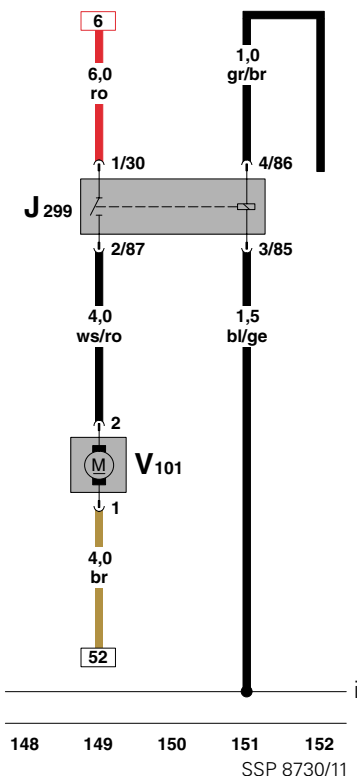

Returning to current track 149, we see that the 4.0 ws/ro wire runs to the switch portion of the relay (illustration SSP8730/11).

Following the 6.0 ro wire from where it leaves terminal 1/30 on the relay, through its current track continuation, we see that the motor receives direct battery power (30) from fuse S162. Checking the fuse on the vehicle shows it to be good.

Locate relay J299, and pull it from its socket. Using a wire from the VAS 1978 wiring repair kit of the proper size, and with the proper size terminals, we can jump the relay socket from terminal 1/30 to 2/87. The Secondary Air Injection (AIR) pump motor V101 runs, verifying that this section of the circuit is functioning correctly.

Let's trace out the power side of the solenoid in the relay. Terminal 85 on a standard 4-pin relay is usually the power side. Following the 1.5 bl/ge wire down, we see that it leads to welded connection continuation "i".

In both directions along "i", we see that this is welded connection E30 in the engine wiring harness. It supplies power to many of the actuators in the engine management system. Since there are no other faults in the Engine Management System, we can assume that fuse 43 (S243) on current track 156 is good. To test this circuit correctly, let's trace that power back to its source.

Following the circuit from Fuse S243 up to the central relay panel and over internal connection "j", we see that this power comes from the switch side of J17, the fuel pump relay. This is important for testing. We know that we will only have power at terminal 3/85 of the Secondary Air Injection (AIR) pump relay J299 when the fuel pump relay is energized.

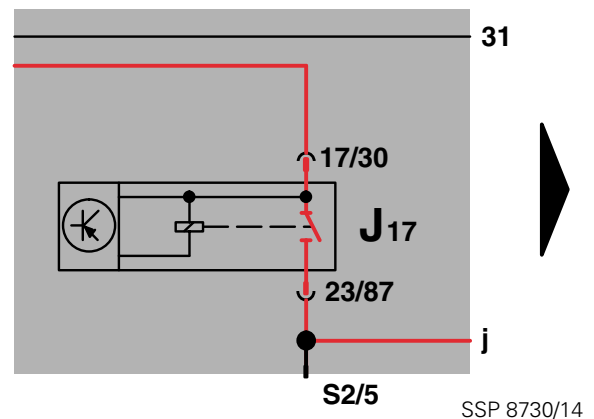
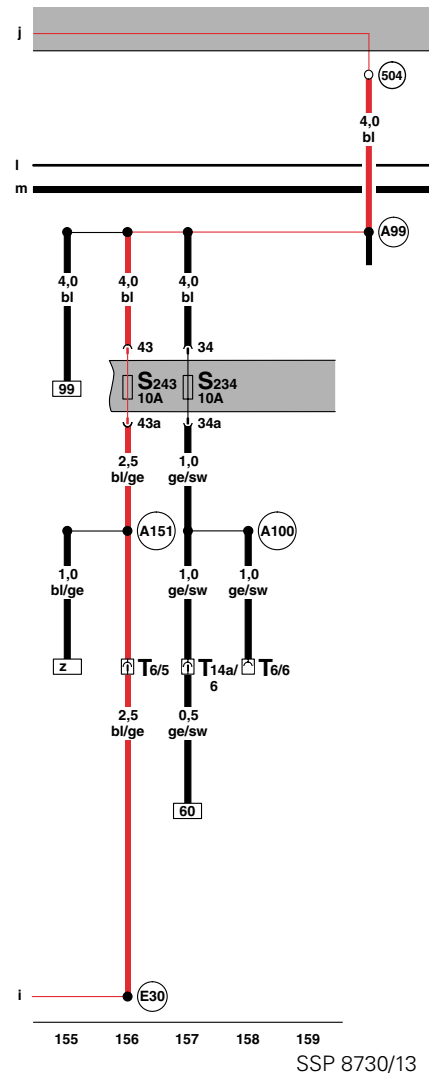

Navigation 3

Go to the Secondary Air pump relay J299 on page 41/12 (or see below). Follow the 1.0 gr/br wire from terminal 4/86 to terminal T121/66 on the Motronic ECM J220. Note that somewhere in the harness it appears that the wire enters an unidentified connection, and changes size. This wire carries the ground signal that energizes the relay.

Now let's test the solenoid side of the circuit. Connect the appropriate test equipment, such as an LED test light, multimeter, or the Digital Storage Oscilloscope of the VAS 5051, between terminals 4/86 and 3/85 of the relay socket. We then activate the circuit (using the VAS 5051) and see that the proper signal is going to the relay socket.

Since the circuit appears to be complete, the next step would be to replace the relay and retest. Doing this, we find that the circuit operates correctly. We can now check, and if necessary, erase any DTCs, quality check the vehicle, and return it to the customer.

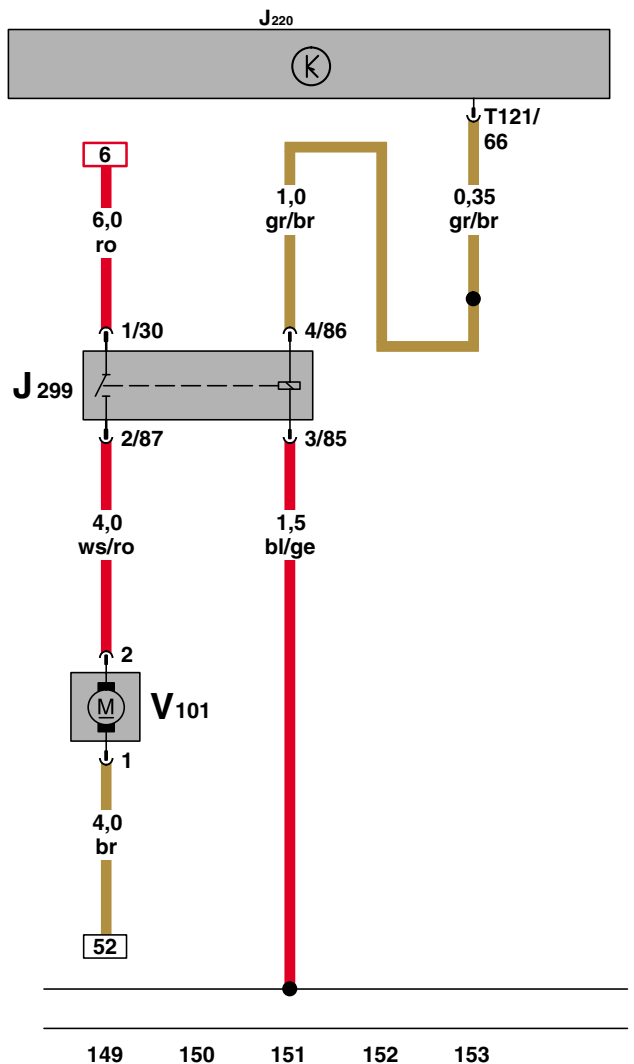

SSP 8730/16



Navigation 4

Often, when we are diagnosing an electrical problem on a vehicle, we will need to look at more than one wiring diagram. In this final example, we will look at a simple problem that shows the importance of considering all of the applicable wiring diagrams for the vehicle that we are diagnosing.

Let's consider a customer concern of an inoperative speedometer. The vehicle is a 2000 Jetta GLS, equipped with a 1.8T engine and manual transmission.

A road test verifies that neither the speedometer nor the odometer is operating. There is also a DTC stored in the engine ECM memory, showing no signal from the vehicle speed sensor (VSS).

Note:

Refer to wiring diagrams 29 and 41 in appendix E for this example.

From the table of contents for wiring diagram 41 (page 40), we see that the vehicle speed sensor circuit is shown on page 41/14.

Looking at wiring diagram page 41/14, we locate the VSS (G22), and trace the power back to fuse 7 (S7). We find that the fuse is blown. After locating the 14 pin connector in the engine compartment wiring duct (T14a), and some testing with a multimeter, we find there is a short to ground between terminal 7a on the fuse box, and terminal T14a/2.

Looking at welded connection B163 shows it to be open ended. This often indicates that the weld is continued on another wiring diagram. Since we located the VSS in the 1.8T engine wiring diagram, one place to look would be the Standard Equipment wiring diagram for this vehicle, number 29.

Looking through the legend at the bottom of each page in wiring diagram 29, we find weld connection B163 on page 29/3.

Following the current track continuation from B163 to current track 122, we find that the 1.0 sw/gn wire runs to the backup light switch. In the engine compartment, we find that this wire has been pinched in the engine compartment wiring harness near the starter. We repair the wire using the VAS 1978 wiring repair kit, replace the fuse. Check, and if necessary, erase any DTCs, quality check the vehicle, and return it to the customer.

One thing to note: in vehicles equipped with an automatic transmission, the circuit for fuse S7 would be different. We would need to look in the wiring diagram for that system as well.

Notes

Appendix A: Component Symbols

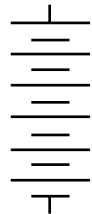

Battery

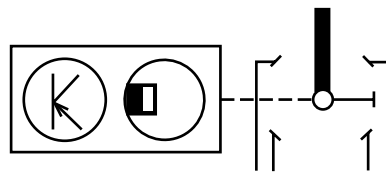

Distributor
(electrical)

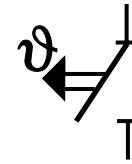

Thermally
operated
switch

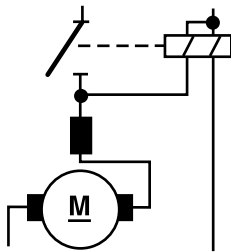

Starter



Spark plug
connector
and plug

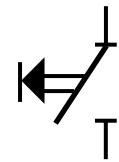

Push-button switch
(manually operated)

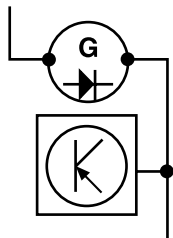

Generator



Glow plug
heater element

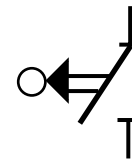

Mechanically
operated
switch



Ignition coil



Manually
operated
switch

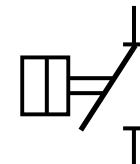

Pressure
operated
switch

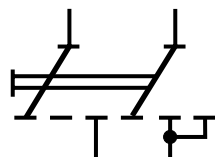

Multiple switch
(manually operated)

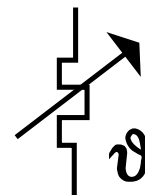

Heater element
(temperature dependent)

SSP 8730/02

Appendix A: Component Symbols



Diode



Zener diode



Diode
(light sensitive)



Light bulb

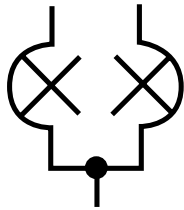

Light bulb
(dual filament)

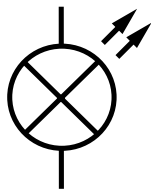

LED

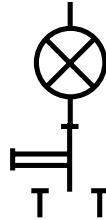

Interior light

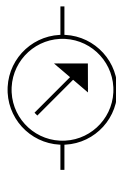

Instrument
(gauge)

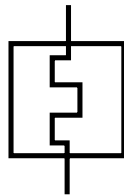

Rear window defogger
heat element



Cigarette
lighter

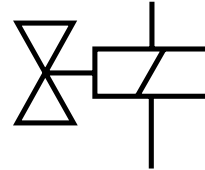

Solenoid valve

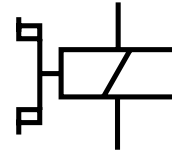

Magnetic clutch



Wire connection
in wiring harness



Resistance wire

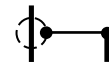

Shield wire

SSP 8730/03

Appendix A: Component Symbols

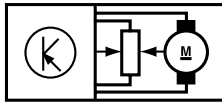

Control motor,
headlight range
adjustment

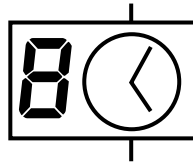

Digital clock

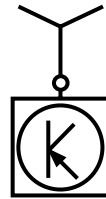

Antenna with
electronic antenna
amplifier

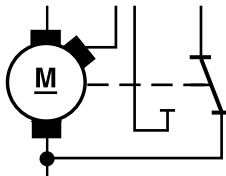

Wiper motor
(2-speed)



Multifunction
indicator

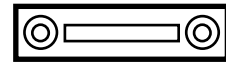

Radio

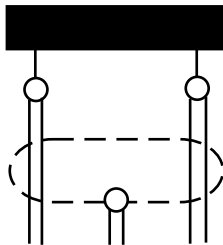

Crankshaft
position sensor



Airbag spiral
spring

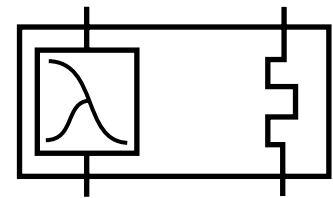

Heated oxygen
sensor

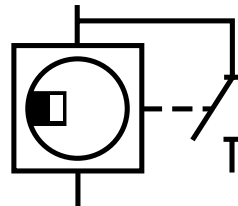

Speed sensor

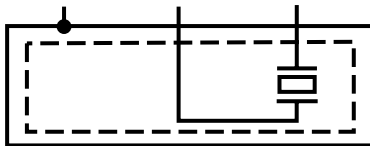

Camshaft
position sensor

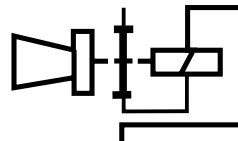

Horn

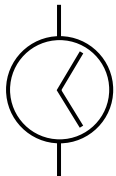

Analog clock

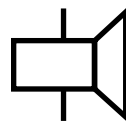

Speaker

SSP 8730/04

Appendix B: Wiring Connections



Wiring junction



Internal connection in a component



Disconnected wire terminal



Slip contact



Multipoint connector or component



Push-on connector

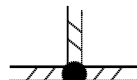

Wires connected



Connected wire terminal

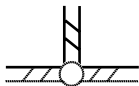

Wires connected (detachable junction)

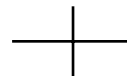

Wires not connected

SSP 8730/30

Appendix C: Component Codes and Wiring

Component Code Prefixes

- A** Battery
- B** Starter
- C** Alternator/Generator
- D** Ignition/Starter switch
- E** Switches - these are usually more complex switches: A/C control head, sunroof regulator
- F** Switches - door, hood, brake, clutch, trunk, multifunction, etc.
- G** Gauges and sensors
- H** Horn
- J** Control modules, Relays, Electronic Relays
- K** Indicator/Warning lights
- L** Lights
- M** Lights
- N** Solenoids/Inductors/Ignition - Fuel injectors, Purge, Ignition coil, Ignition module, etc.
- P** Spark plug connector
- Q** Spark Plugs
- R** Radio, CD, Telephone, Navigation
- S** Fuse, circuit breaker, protection device
- T** Wire connector
- V** Motor - Window motors, vacuum pumps, etc.
- W** Lights - Interior, Trunk
- Z** Heating elements - O₂ sensor heater, heated seats, heated mirrors, etc.

Color Codes

German Abbreviation to English

- bl Blue
- br Brown
- ge Yellow
- gn Green
- ro Red
- sw Black
- li Violet
- ws White

Occasionally in a complex circuit, other colors may be used. These are listed below.

- el Cream
- nf Neutral
- og Orange
- rs Pink
- hbl Light Blue
- hgn Light Green
- rbr Maroon
- x Braided cable
- y High tension
- z Non-cable

American Wire Gauge (AWG) Conversion to Metric

The conversion from AWG to Metric (mm²) is shown below.

AWG	mm ²
22	0.35
20	0.50
18	0.75
16	1.00
14	1.50
12	2.50
10	4.00
8	6.00
4	16.0
2	25.0
2	35.0

Appendix D: DIN Standards

DIN standards for terminal designations

The following are examples of the common Volkswagen DIN list for terminal designations:

- 1 Ignition coil, ignition distributor - Low voltage
- 1a To contact breaker I (Ignition distributor with two separate circuits)
- 1b To contact breaker II (Ignition distributor with two separate circuits)
- 4 Ignition coil, ignition distributor - high voltage
- 4a From ignition coil I (Ignition distributor with two separate circuits)
- 4b From ignition coil II (Ignition distributor with two separate circuits)
- 15 Switched (+) downstream of battery (output of ignition/driving switch)
- 15a Output at ballast resistor to ignition coil and starter
- 17 Glow plug and starter switch - Start
- 19 Glow plug and starter switch - Preheat
- 30 Input from battery (+) term., direct 12/24 V series-parallel battery switch
- 30a Input from (+) terminal of battery II
- 31 Battery negative terminal, or ground, direct
- 31b Return line to battery negative terminal, or ground via switch or relay (switched negative)
- 31a Return line to battery II, negative (12/24 V series-parallel battery switch)
- 31c Return line to battery I, negative (12/24 V series-parallel battery switch)

Electric motors

- 32 Return line
- 33 Main terminal connection
- 33a Self-parking switch-off
- 33b Shunt field
- 33f For second lower-speed range
- 33g For third lower-speed range
- 33h For fourth lower-speed range
- 33L Counterclockwise rotation
- 33R Clockwise rotation

Starters

- 45 Separate starter relay, output; starter, input (main current)
Two-starter parallel operation - Starting relay for engagement current
- 45a Output, starter I, Input, starters I and II
- 45b Output, starter II
- 48 Terminal on starter & on start-repeating relay for monitoring starting

Turn-signal flashers (pulse generators)

- 49 Input
- 49a Output
- 49b Output, second circuit
- 49c Output, third circuit

Appendix D: DIN Standards

Starter control

- 50 Starter control (direct)
- 50a Series-parallel battery switch - Output for starter control
- 50b with parallel operation of two starters with sequential control
Starting relay for sequential control of the engagement current during parallel operation of two starters
- 50c Input at starting relay for starter I
- 50d Input at starting relay for starter II
- 50e Start-locking relay Input
- 50f Start-locking relay Output
- 50g Start-repeating relay Input
- 50h Start-repeating relay Output

Wiper motors

- 53 Wiper motor, input (+)
- 53a Wiper (+), self-parking switch-off
- 53b Wiper (shunt winding)
- 53c Electric windshield-washer pump
- 53e Wiper (brake winding)
- 53l Wiper motor with permanent magnet and third brush (for higher speed)

Lighting

- 55 Fog lamp
- 56 Headlamp
- 56a High beam, high-beam indicator lamp
- 56b Low beam
- 56d Headlamp-flasher contact
- 57a Parking lamp
- 57L Parking lamp, left
- 57R Parking lamp, right
- 58 Side-marker, tail, license plate, and instrument panel lamps
- 58b Dimmer
- 58d Dimmer
- 58L License-plate lamp, left
- 58R License-plate lamp, right

Alternators and voltage regulators

- 61 Alternator charge-indicator lamp
- B+ Battery positive
- B- Battery negative
- D+ Dynamo positive
- D- Dynamo negative
- DF Dynamo field
- DF1 Dynamo field 1
- DF2 Dynamo field 2
- U,V,W Alternator terminals
- 75 Radio, cigarette lighter
- 76 Speakers

Switches

Break contact (NC) and changeover switches

- 81 Input
- 81a Output 1, NC side
- 81b Output 2, NC side

Make contact (NO) switches

- 82 Input
- 82a Output 1
- 82b Output 2
- 82z Input 1
- 82y Input 2

Multiple-position switches

- 83 Input
- 83a Output, position 1
- 83b Output, position 2
- 83L Output, left-hand position
- 83R Output, right-hand position

Appendix D: DIN Standards

Relays/Current relays

84 Input, actuator and relay contact

84a Output, actuator

84a Output, relay contact

Switching relays

85 Output, actuator (end of winding to ground or negative)

86 Input, actuator (start of winding)

86a Start of winding or 1st winding

86b Winding tap or 2nd winding

Relay contact for break (NC) and changeover contacts

87 Input

87a Output 1 (NC side)

87b Output 2

87c Output 3

87z Input 1

87y Input 2

87x Input 3

Relay contact for make (NO) contact and changeover contacts

88 Input

88a Output 1

88b Output 2

88c Output 3

88z Input 1

88y Input 2

88x Input 3

Directional signals (turn signal flashers)

C Indicator lamp 1

C2 Indicator lamp 2

C0 Main terminal connection for separate indicator circuits actuated by the turn signal switch

C3 Indicator lamp 3 (e.g., when towing two trailers)

L Turn-signal lamps, left

R Turn-signal lamps, right

Appendix E: Wiring Diagrams

Golf/Jetta - Standard Equipment, from May 1999

	No./Page
Relay locations29/1
Battery, ignition/starter switch29/2
Instrument cluster, clutch pedal position (CPP) switch, starting interlock relay29/3
Instrument cluster, tachometer, speedometer, odometer, display antitheft immobilizer, warning light for anti-theft immobilizer sensor29/4
Instrument cluster, generator (GEN) warning light, digital clock, low fuel level warning light29/5
Instrument cluster, left front brake pad wear sensor, brake pad wear indicator light, headlight high beam indicator light9/6
Instrument cluster, parking brake warning light switch, brake fluid level warning switch, low windshield washer fluid level indication, left and right turn signal indicator lights29/7
Turn signal switch, headlight dimmer/flasher switch, left front turn signal light, light for side marker front left, left headlight29/8
Emergency flasher switch, turn signal relay, right front turn signal light, light for side marker front right, right headlight29/9
Back-up light switch, left rear turn signal light, left back-up light, left brake/tail light, high-mount brake light (Golf only)29/10
Brake light switch, right rear turn signal light, right back-up light, right brake/tail light, high mount brake light (Jetta only)29/11
Data Link Connector (DLC) radio connection, cigarette lighter29/12
Light switch, rear fog light switch, instrument panel vent illumination29/13
License plate light29/14
Dual tone horn, fuel tank door remote29/15
Instrument panel light dimmer switch, glove compartment light, rear window, defogger switch, heated rear window29/16
Fresh air blower, fresh air/recirculating flap switch, fresh air blower29/17
Motor for rear windshield wiper, windshield and rear window washer pump29/18
Windshield wiper/washer switch, windshield wiper/intermittent regulator, windshield wiper motor, wiper/washer intermittent relay29/19

Appendix E: Wiring Diagrams

1.8L - Engine - Motronic Multiport Fuel Injection (MFI)/110kW, code AWD, from November 1999

	No./Page
Generator (GEN), starter41/2
Motronic engine control module (ECM) power supply relay41/3
Motronic engine control module (ECM) ignition system41/4
Motronic engine control module (ECM)41/5
Motronic engine control module (ECM), (ECT) sensor, charge air pressure sensor, camshaft position (CMP) sensor 2, wastegate bypass regulator valve, recirculating valve for turbocharger41/6
Motronic engine control module (ECM), angle sensor for throttle drive (power accelerator actuation), intake air temperature (IAT) sensor, knock sensor (KS) 1, leak detection pump (LDP)41/7
Motronic engine control module (ECM), pressure switch/power steering, engine speed (RPM) sensor, knock sensor (KS) 241/8
Motronic engine control module (ECM), heated oxygen sensor (HO2S), injectors41/9
Motronic engine control module (ECM), throttle position (TP) sensor, oxygen sensor (O2S) behind three way catalytic converter (TWC), evaporative emission (EVAP) canister purge41/10
Motronic engine control module (ECM), fuel pump (FP) relay, cruise control switch, mass air flow (MAF) sensor41/11
Motronic engine control module (ECM), secondary air injection (AIR) pump system, brake light switch, clutch vacuum vent valve switch, brake vacuum vent valve switch41/12
Fuel pump (FP), fuel level sensor, engine coolant level (ECL) sensor41/13
Instrument cluster, oil pressure switch, speedometer vehicle speed sensor (VSS), oil pressure warning light41/14
Instrument cluster, engine coolant temperature (ECT) gauge, tachometer, speedometer, generator (GEN) warning light41/15
Instrument cluster, multi-function indicator (MFI), outside air temperature sensor, electronic power control (EPC) warning lamp41/16

Golf /Jetta - Standard Equipment,

from May1999

Deviate relay location and fuseplacements as well as the locations of multiple connectors see section "component locations".

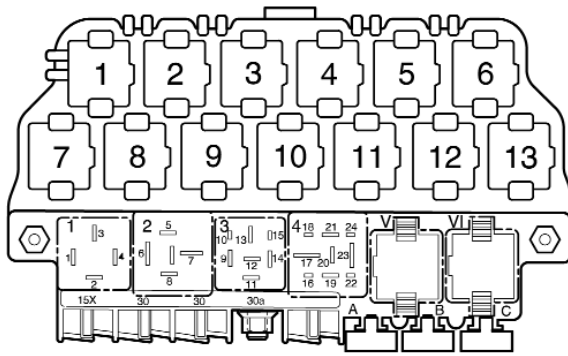

97-14163

Relay location on the thirteenfold auxiliary relay panel, above relay panel:

- 3** Starting Interlock Relay (53)

Relay panel:

- 1** Dual Horn Relay (53)
- 2** Load Reduction Relay (18)
- V** Wiper/Washer Intermittent Relay (377)
- VI**

Note: Number in parentheses indicates production control number stamped on relay housing.

Fuse colors

- 30 A - green
- 25 A - white
- 20 A - yellow
- 15 A - blue
- 10 A - red
- 7,5 A - brown
- 5 A - beige
- 3 A - violet

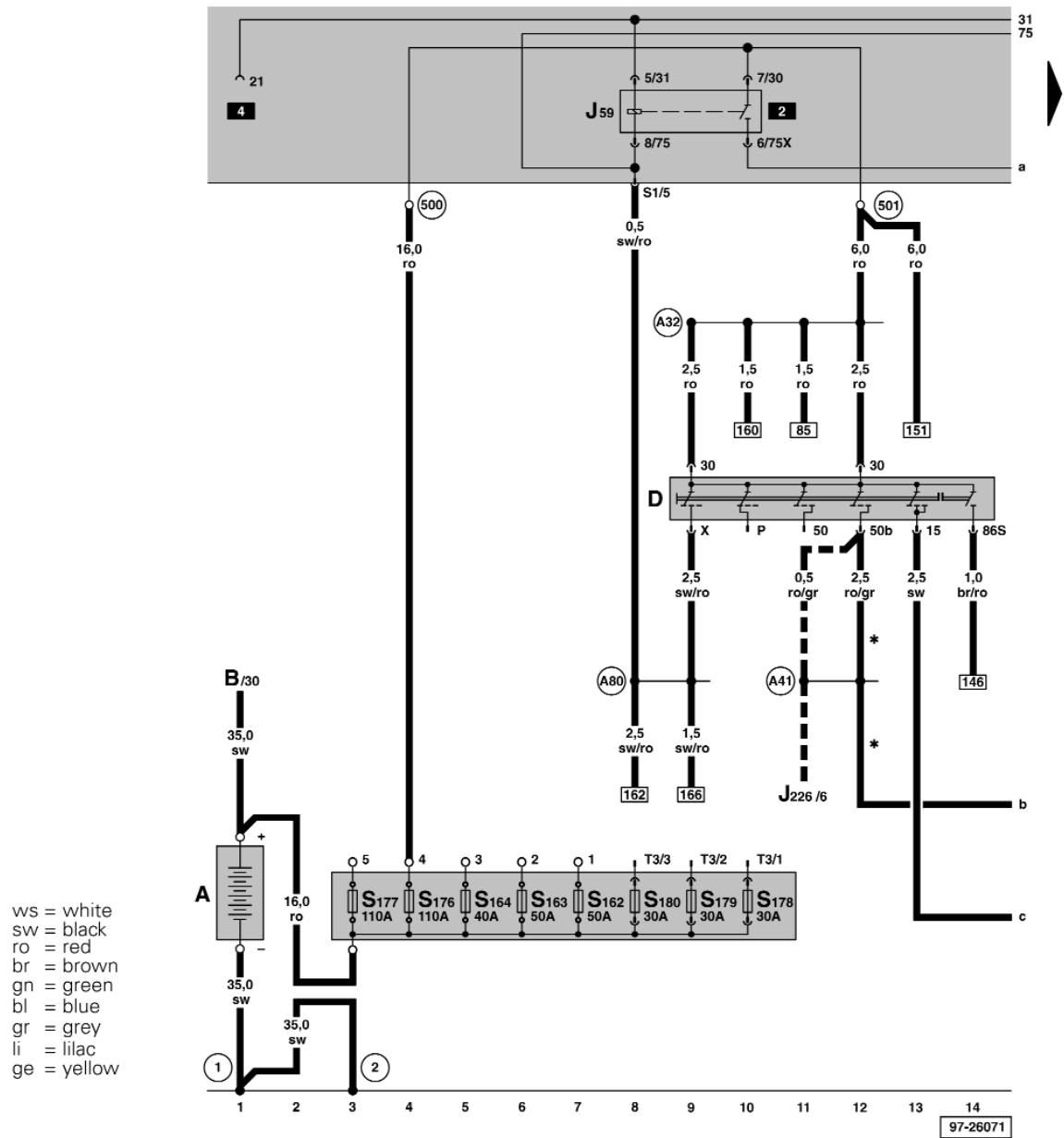

- A - Battery
- B - Starter
- D - Ignition/Starter Switch
- J59 - Load Reduction Relay
- J226 - Park/Neutral Position (PNP) Relay
- S162 - Fuse -1- (30) in fuse bracket/battery
- S163 - Fuse -2- (30) in fuse bracket/battery
- S164 - Fuse -3- (30) in fuse bracket/battery
- S176 - Fuse -4- (30) in fuse bracket/battery
- S177 - Fuse -5- (30) in fuse bracket/battery
- S178 - Fuse -6- (30) in fuse bracket/battery
- S179 - Fuse -7- (30) in fuse bracket/battery
- S180 - Fuse -8- (30) in fuse bracket/battery
- T3 - 3-Pin Connector

Battery, ignition/starter switch

Edition 08/99
 USA.5102.04.21

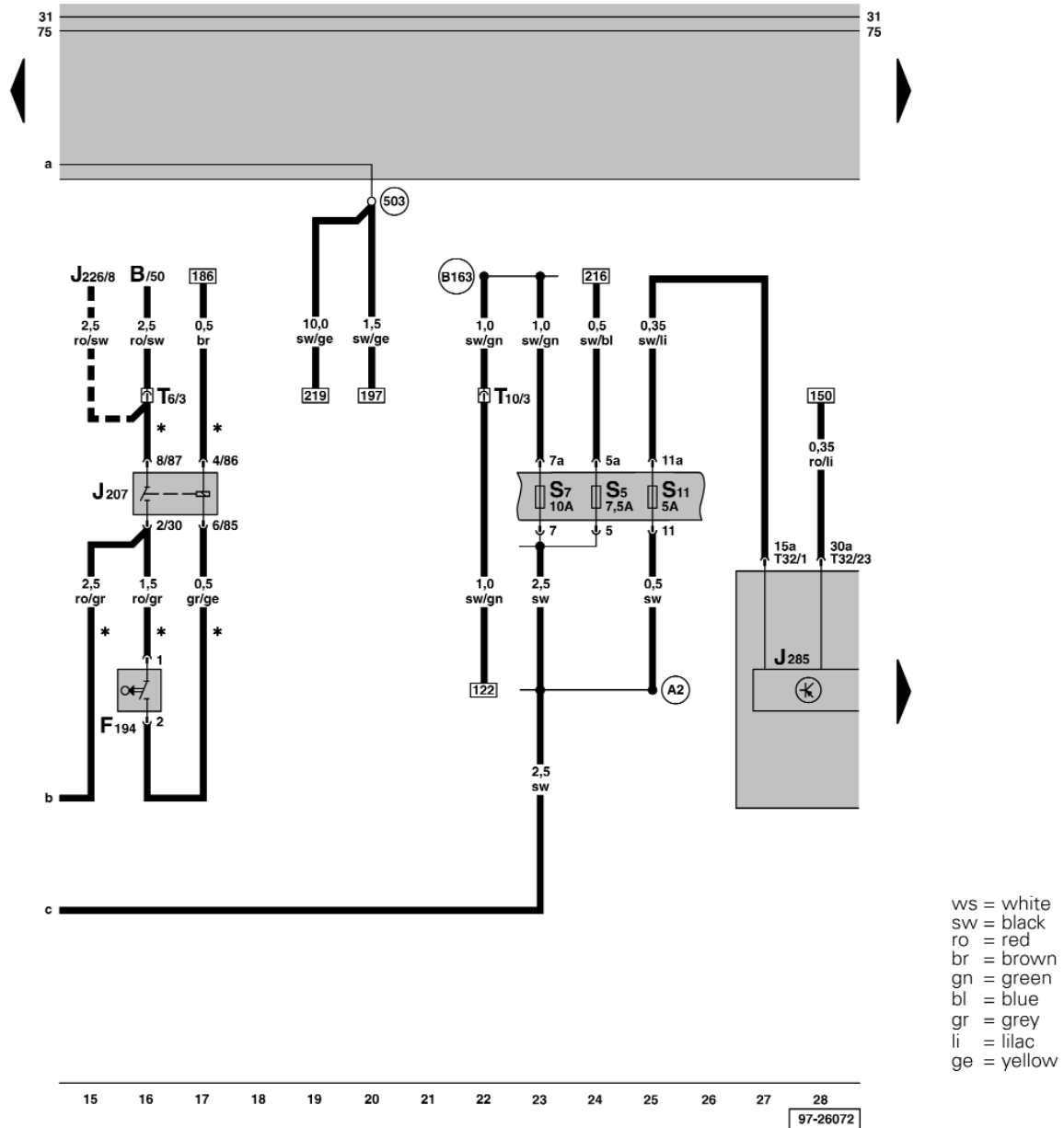

- B - Starter
- F194 - Clutch Pedal Position (CPP) Switch*
- J207 - Starting Interlock Relay*
- J226 - Park/Neutral Position (PNP) Relay
- J285 - Control module with indicator unit in instrument panel insert
- S5 - Fuse 5 in fuse holder
- S7 - Fuse 7 in fuse holder
- S11 - Fuse 11 in fuse holder
- T6 - 6-Pin Connector, brown, in protective housing for connectors, in plenum chamber, left
- T10 - 10-Pin Connector, orange, in protective housing for connectors, in plenum chamber, left
- T32 - 32-Pin Connector, blue

- (A2) - Plus connection (15), in instrument panel wiring harness
- (B163) - Plus connector -1- (15) in wiring harness interior
- (503) - Threaded connection -2- (75x) on the relay plate
- * - Manual transmission only
- Automatic transmission only

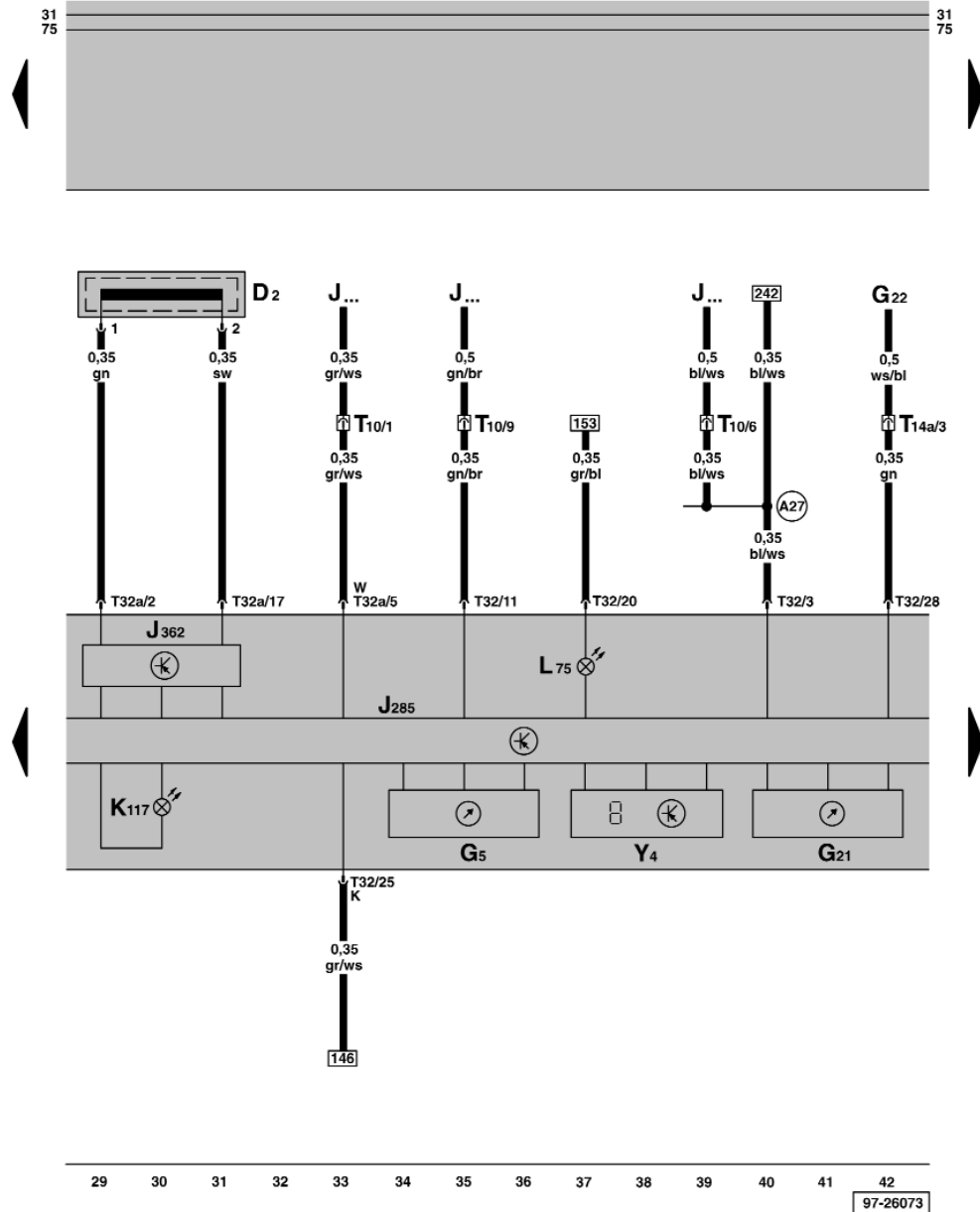

- D2 - Induction coil of antitheft immobilizer
- G5 - Tachometer
- G21 - Speedometer
- G22 - Speedometer Vehicle Speed Sensor
- J285 - Control module with indicator unit in instrument panel insertControl module for anti-theft immobilizer
- J362 - Control module for anti-theft immobilizer
- J... - Engine Control Module (ECM)
- K117 - Warning light for anti-theft immobilizer sensor
- L75 - Digital Display Light
- T10 - 10-Pin Connector, orange, in protective housing for connectors, in plenum chamber, left
- T14a - 14-Pin Connector, in engine compartment, in wiring duct, left
- T32 - 32-Pin Connector, blue

- T32a - 32-Pin Connector, green
- Y4 - Odometer Display
- (A27) - Wire connection (vehicle speed signal), in instrument panel wiring harness

Instrument cluster, tachometer, speedometer, odometer display antitheft immobilizer, warning light for anti-theft imobilizer sensor

Edition 08/99
 USA.5102.04.21

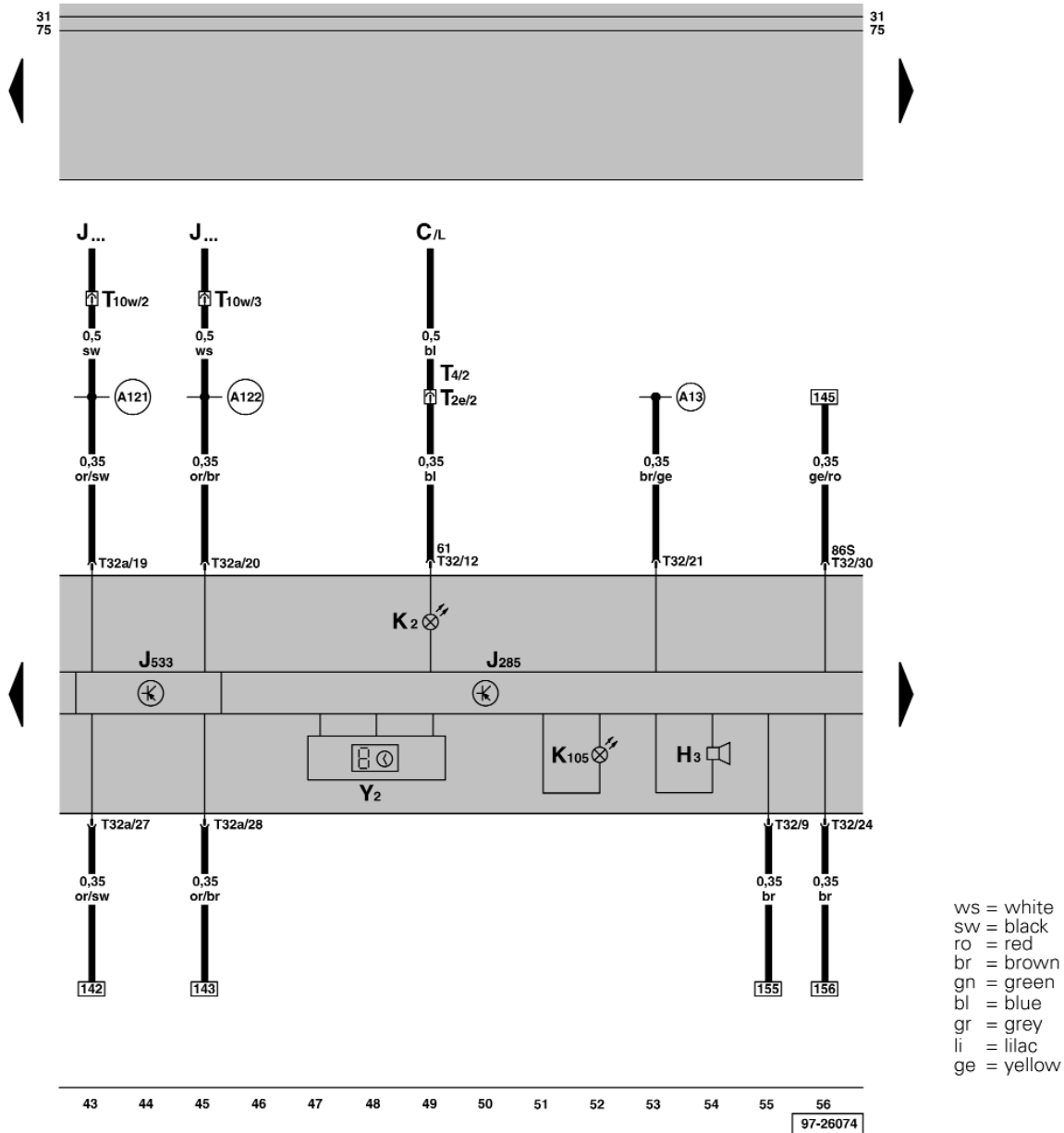

- C - Generator (GEN)
- H3 - Warning buzzer
- J285 - Control module with indicator unit in instrument panel insert
- J533 - Data Bus On Board Diagnostic Interface
- J... - Engine Control Module (ECM)
- K2 - Generator (GEN) Warning Light
- K105 - Low Fuel Level Warning Light
- T2e - Double Connector, near starter (in vehicles without air conditioning)
- T4 - 4-Pin Connector, near starter (in vehicles with air conditioning)
- T10w- 10-Pin Connector, white, in protective housing for connectors, in plenum chamber, left
- T32 - 32-Pin Connector, blue
- T32a - 32-Pin Connector, green
- Y2 - Digital Clock
- (A13) - Wire connection (door contact switch) in instrument panel wiring harness
- (A121) - Connection (high bus), in instrument panel wiring harness
- (A122) - Connection (low bus), in instrument panel wiring harness

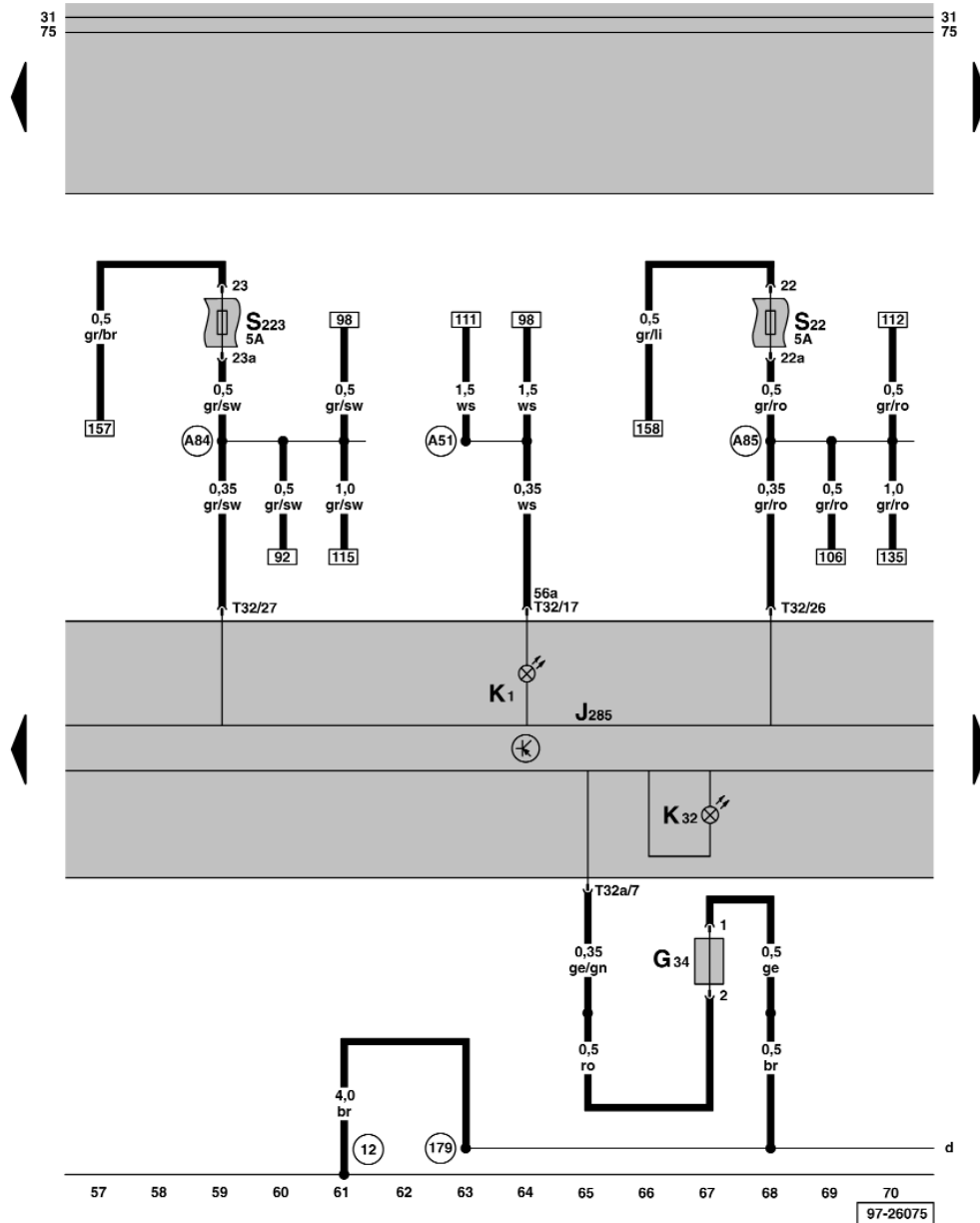

ws = white
 sw = black
 ro = red
 br = brown
 gn = green
 bl = blue
 gr = grey
 li = lilac
 ge = yellow

- G34 - Left Front Brake Pad Wear Sensor
- J285 - Control module with indicator unit in instrument panel insert
- K1 - Headlight High Beam Indicator Light
- K32 - Brake Pad Wear Indicator Light
- S22 - Fuse 22 in fuse holder
- S223 - Fuse 23 in fuse holder
- T32 - 32-Pin Connector, blue
- T32a - 32-Pin Connector, green

- (A84) - Connector (58L) in instrument panel wiring harness
- (A85) - Connector (58R) in instrument panel wiring harness

- (12) - Ground connection, in engine compartment, left
- (179) - Ground connection, in left headlight wiring harness
- (A51) - Wire connection (56), in instrument panel wiring harness

Instrument cluster, left front brake pad wear sensor, brake pad wear indicator light, headlight high beam indicator light

Edition 08/99
 USA.5102.04.21

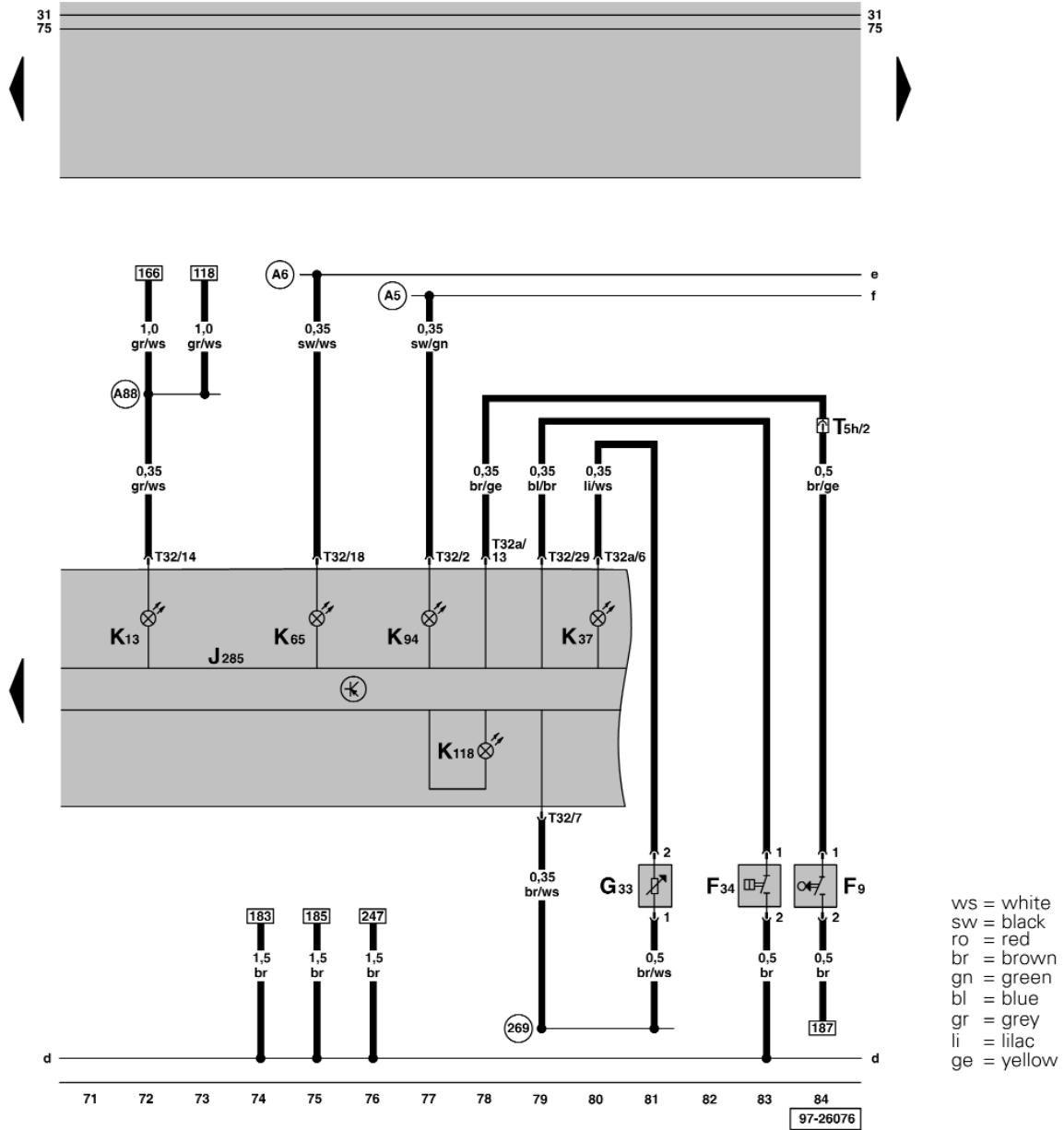

- F9 - Parking Brake Warning Light Switch
- F34 - Brake Fluid Level Warning Switch
- G33 - Windshield Washer Fluid Level Sensor
- J285 - Control module with indicator unit in instrument panel insert
- K13 - Rear Fog Light Indicator Light
- K37 - Low Windshield Washer Fluid Level Indicator Light
- K65 - Left Turn Signal Indicator Light
- K94 - Right Turn Signal Indicator Light
- K118 - Warning light for brake system
- T5h - 5-Pin Connector, near left A-pillar, lower part, in harness
- T32 - 32-Pin Connector, blue
- T32a - 32-Pin Connector, green

- (269) - Ground connector (sensor ground) -1-, in instrument panel wiring harness
- (A5) - Plus connection (right turn signal), in instrument panel wiring harness
- (A6) - Plus connection (left turn signal), in instrument panel wiring harness
- (A88) - Connector fog light, in instrument panel wiring harness

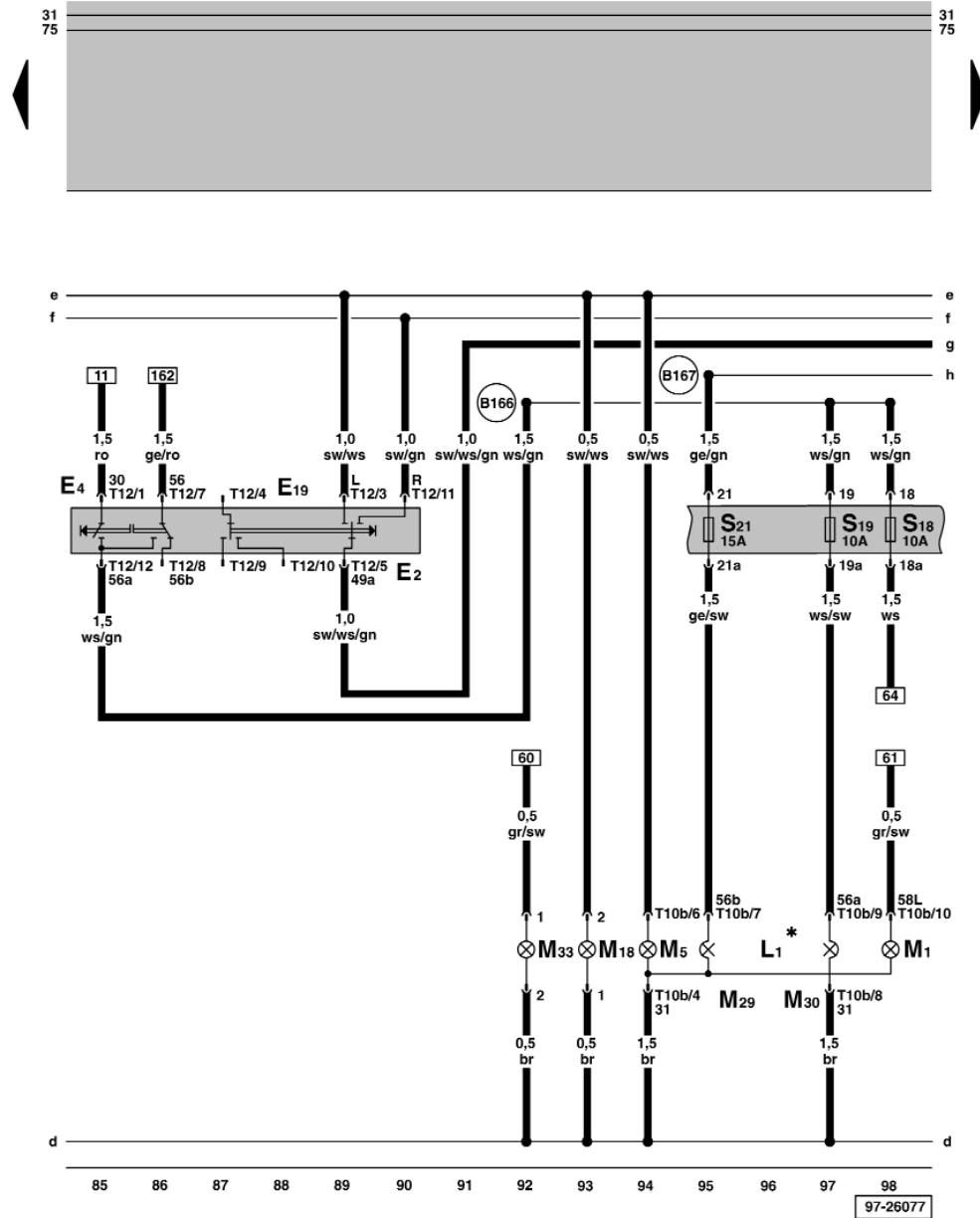

ws = white
 sw = black
 ro = red
 br = brown
 gn = green
 bl = blue
 gr = grey
 li = lilac
 ge = yellow

- E2 - Turn signal switch
- E4 - Headlight Dimmer/Flasher Switch
- E19 - Park Light Switch
- L1 - Left Headlight*
- M1 - Left Parking Light
- M5 - Left Front Turn Signal Light
- M18 - Left, Side Turn Signal Light
- M29 - Left Low Beam Headlight (Golf only)
- M30 - Left High Beam Headlight (Golf only)
- M33 - Light for side marker front left
- S18 - Fuse 18 in fuse holder
- S19 - Fuse 19 in fuse holder
- S21 - Fuse 21 in fuse holder
- T10b - 10-Pin Connector
- T12 - 12-Pin Connector

- (B166) - Connection (56a) in passenger compartment wiring harness
- (B167) - Connection (56b) in passenger compartment wiring harness
- * - Jetta only

Turn signal switch, headlight dimmer/flasher switch, left front turn signal light, light for side marker front left, left headlight

Edition 08/99
 USA.5102.04.21

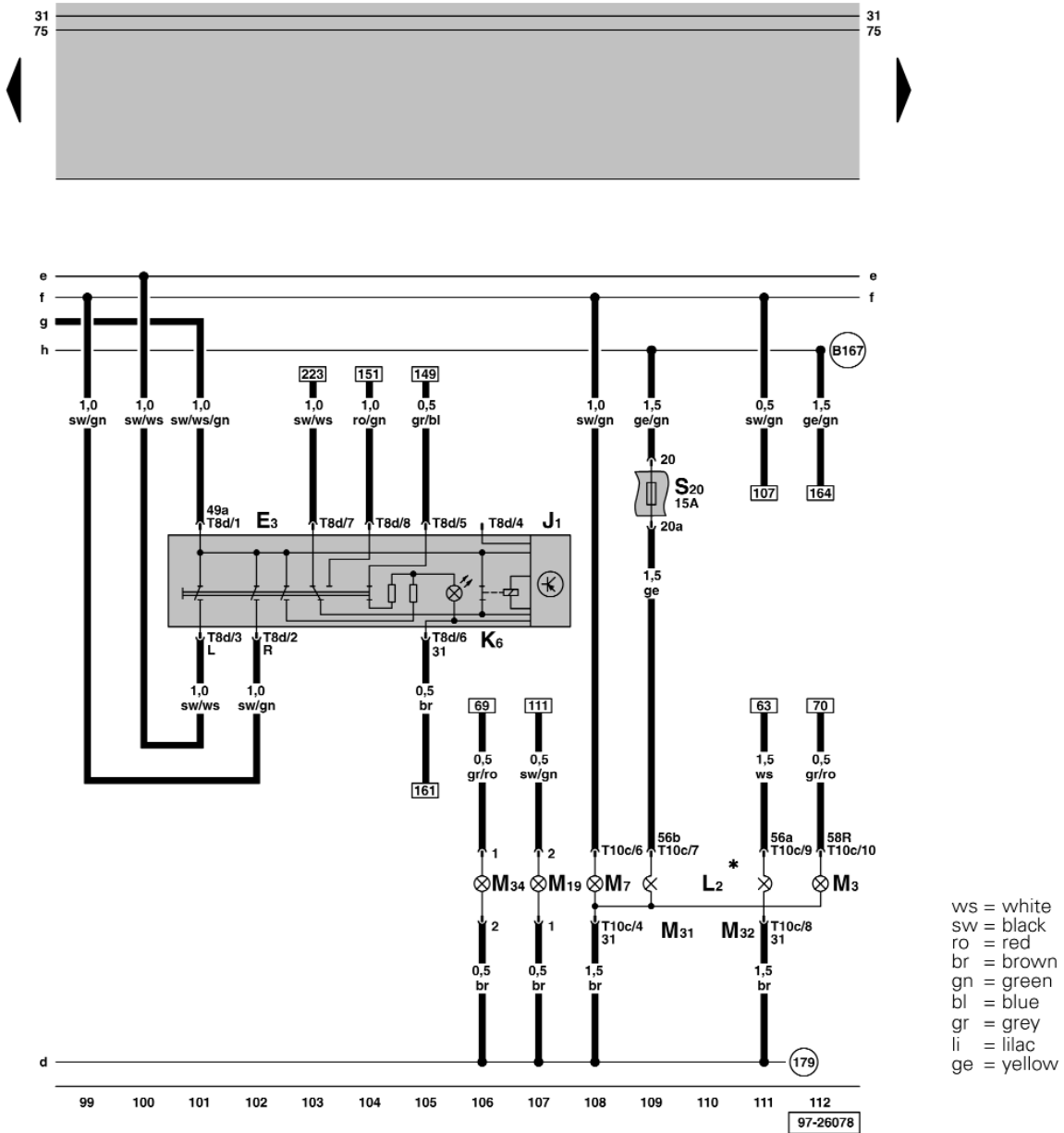

- E3 - Emergency Flasher Switch
- J1 - Turn Signal Relay
- K6 - Indicator light for emergency flasher system
- L2 - Right Headlight*
- M3 - Right Parking Light
- M7 - Right Front Turn Signal Light
- M19 - Right, Side Turn Signal Light
- M31 - Right Low Beam Headlight (Golf only)
- M32 - Right High Beam Headlight (Golf only)
- M34 - Light for side marker front right
- S20 - Fuse 20 in fuse holder
- T8d - 8-Pin Connector
- T10c - 10-Pin Connector
- (179) - Ground connection, in left headlight wiring harness
- (B167) - Connection (56b), in passenger compartment wiring harness
- * - Jetta only

Edition 11/99
 USA.5102.05.21

Emergency flasher switch, turn signal relay, right front turn signal light, light for side marker front right, right headlight

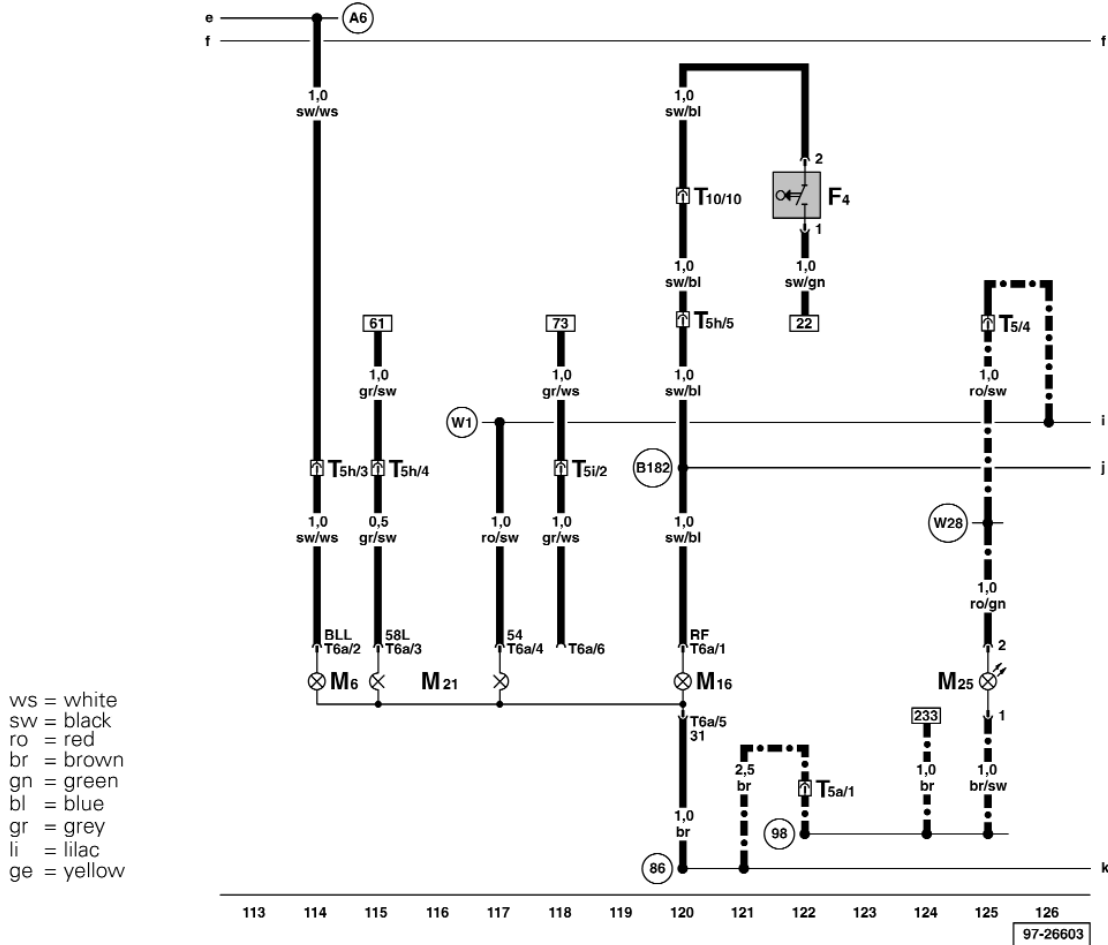
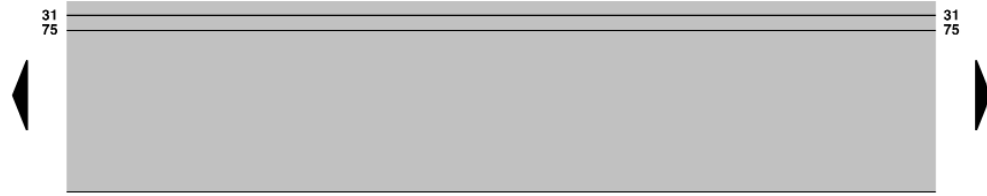

- F4 - Back-Up Light Switch
- M6 - Left Rear Turn Signal Light
- M16 - Left Back-Up Light
- M21 - Left Brake/Tail Light
- M25 - High-mount Brake Light (32 light emitting diodes)
- T5 - 5-Pin Connector, black, connector station C-pillar, left
- T5a - 5-Pin Connector, pink, connector station C-pillar, left (Golf only)
- T5h - 5-Pin Connector, near left A-pillar, lower part, in harness
- T5i - 5-Pin Connector, near left A-pillar, lower part, in harness
- T6a - 6-Pin Connector
- T10 - 10-Pin Connector, orange, in protective housing for connectors, in plenum chamber, left
- (86) - Ground connection -1-, in rear wiring harness
- (98) - Ground connection, in rear lid wiring harness
- (A6) - Plus connection (left turn signal), in instrument panel wiring harness
- (B182) - Connection (RF), in passenger compartment wiring harness
- (W1) - Plus connection (54), in rear wiring harness
- (W28) - Plus connector -2- (54), in wiring harness taillight assembly
- Golf only

Back-up light switch, left rear turn signal light, left back-up light, left brake/tail light, high-mount brake light (Golf only)

Edition 11/99
USA.5102.05.21

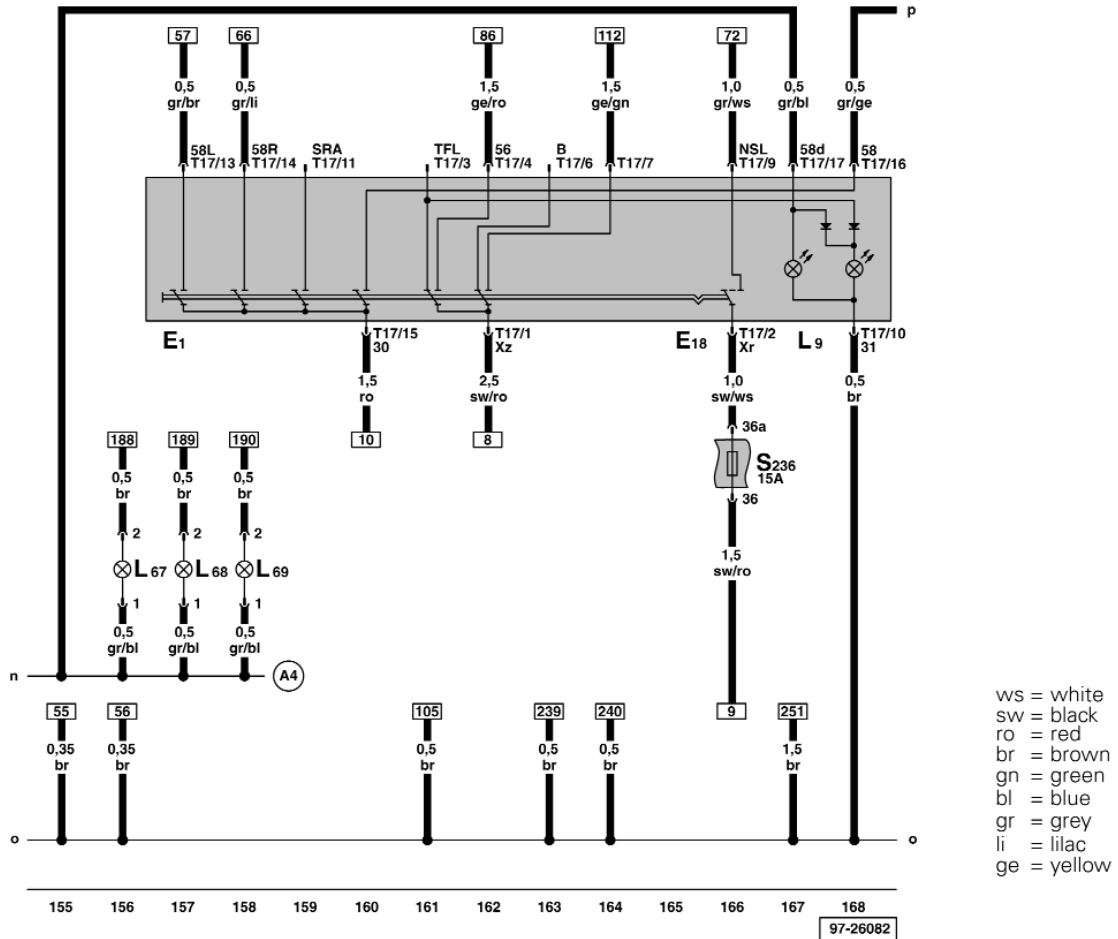
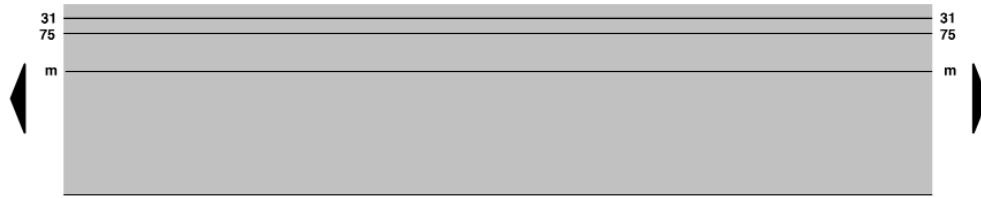

- E1 - Light switch
- E18 - Rear Fog Light Switch
- L9 - Headlight Switch Light
- L67 - Left Instrument Panel Vent Illumination
- L68 - Center Instrument Panel Vent Illumination
- L69 - Right Instrument Panel Vent Illumination
- S236 - Fuse 36 in fuse holder
- T17 - 17-Pin Connector
- (A4) - Plus connection (58b), in instrument panel wiring harness

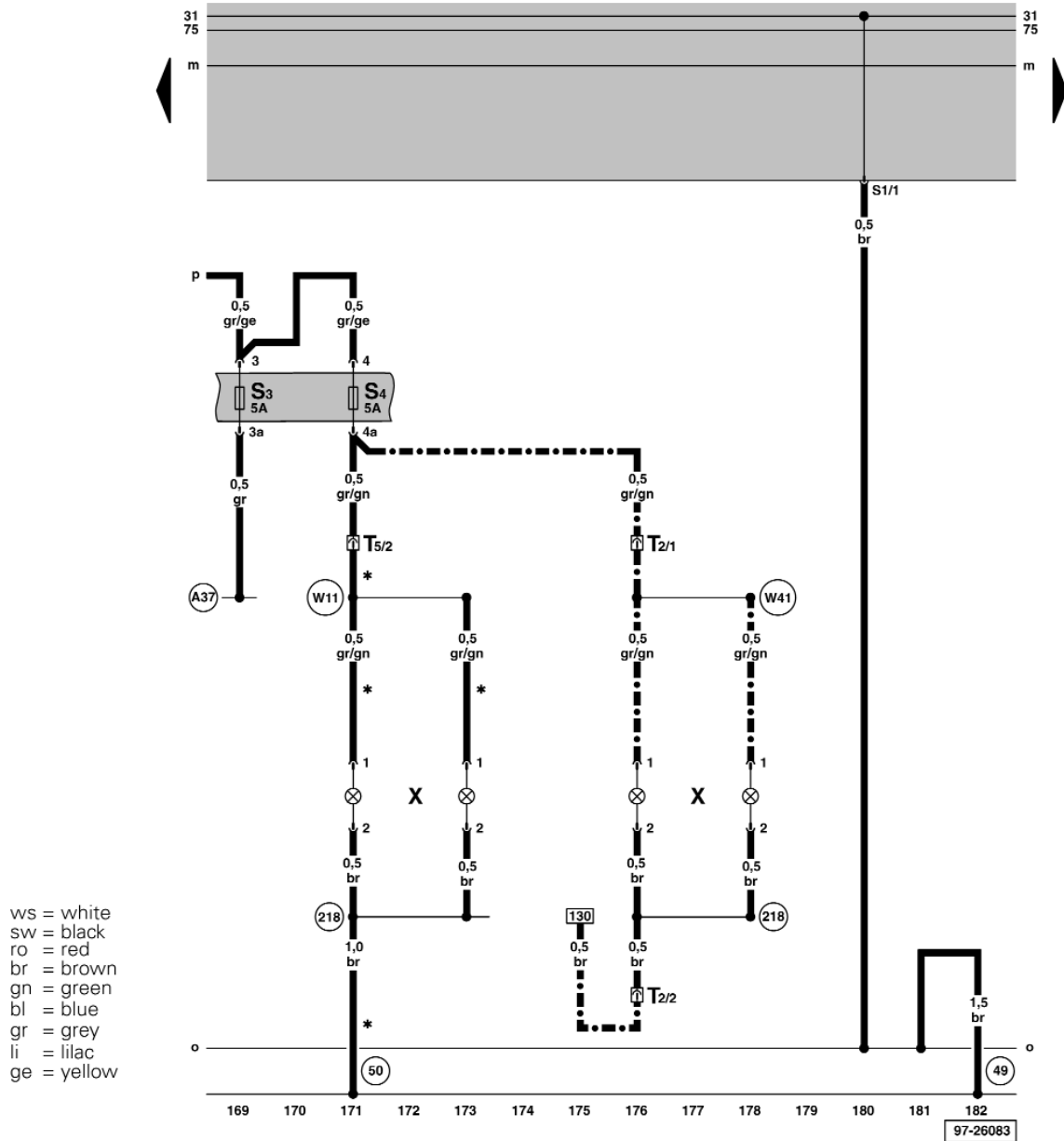

- S3 - Fuse 3 in fuse holder
- S4 - Fuse 4 in fuse holder
- T2 - Double Connector, in luggage compartment, left (Golf only)
- T5 - 5-Pin Connector, black, connector station C-pillar, left
- X - License Plate Light

- (W11) - Wire connection (58), in rear lid wiring harness
- (W41) - Plus connection (58), in wiring harness
- * - Jetta only
- .-.- Golf only

- (49) - Ground connection, on steering column
- (50) - Ground connection, in luggage compartment, left
- (218) - Ground connection -1-, in rear lid wiring harness
- (A37) - Wire connection (58a), in instrument panel wiring harness

License plate light

Edition 08/99
 USA.5102.04.21

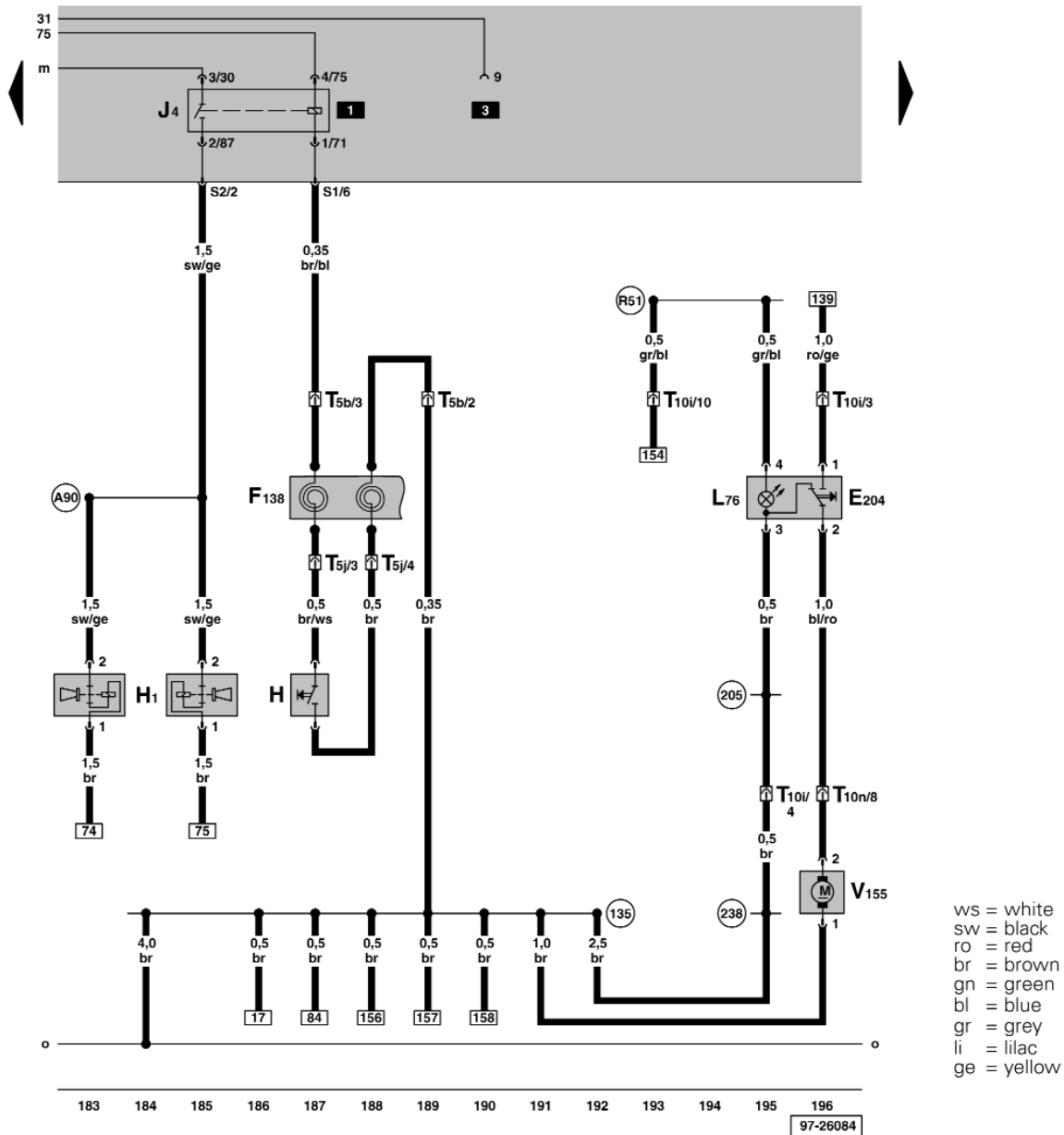

- E204 - Switch for remote/fuel tank door (also see Comfort System with power windows wiring diagram)
- F138 - Airbag Spiral Spring/Return Spring with Slip Ring
- H - Signal horn activation
- H1 - Dual tone horn
- J4 - Dual Horn Relay
- L76 - Push Button Light
- T5b - 5-Pin Connector, on airbag spiral spring
- T5j - 5-Pin Connector, behind driver's airbag
- T10i - 10-Pin Connector, black, connector station A-pillar, left
- T10n - 10-Pin Connector, brown, connector station A-pillar, left
- V155 - Motor for fuel tank lid unlock

- (135) - Ground connection -2-, in instrument panel wiring harness
- (205) - Ground connection, in driver's door wiring harness
- (238) - Ground connection -1-, in wiring harness interior
- (A90) - Connector (dual tone horn), in instrument panel wiring harness
- (R51) - Connection (58b) in door wiring harness, driver side

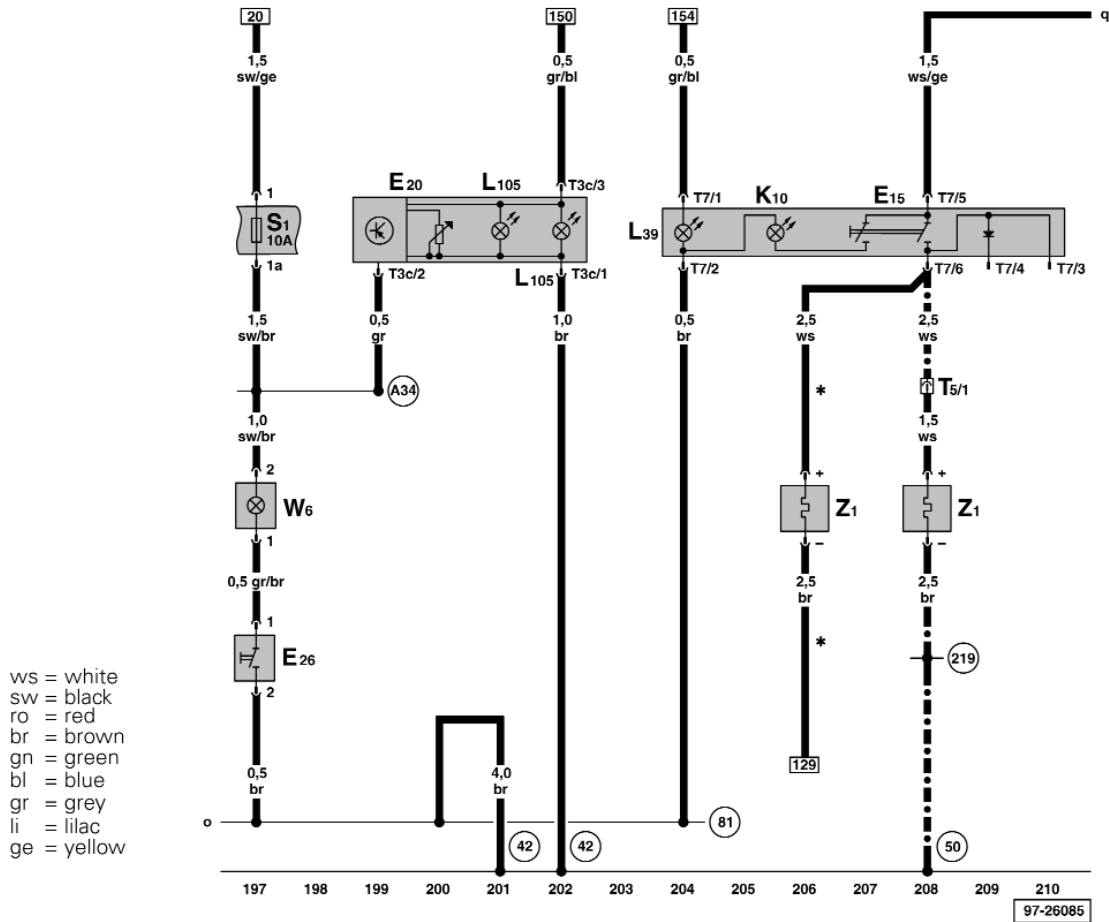

ws = white
 sw = black
 ro = red
 br = brown
 gn = green
 bl = blue
 gr = grey
 li = lilac
 ge = yellow

- E15 - Rear window defogger switch
 - E20 - Instrument Panel Light Dimmer Switch
 - E26 - Glove compartment light switch
 - K10 - Indicator light for heated rear windshield
 - L39 - Rear Window Defogger Switch Light
 - L105 - Illumination for lighting controller
 - S1 - Fuse 1 in fuse holder
 - T3c - 3-Pin Connector
 - T5 - 5-Pin Connector, black, connector station C-pillar, left (Golf only)
 - T7 - 7-Pin Connector
 - W6 - Glove Compartment Light
 - Z1 - Heated rear window
- (42) - Ground connection, beside steering column

- (50) - Ground connection, in luggage compartment, left
- (81) - Ground connection -1-, in instrument panel wiring harness
- (219) - Ground connection -2-, in rear lid wiring harness
- (A34) - Wire connection (75x), in instrument panel wiring harness
- * - Jetta only
- .-.- Golf only

Instrument panel light dimmer switch, glove compartment light, rear window defogger switch, heated rear window

Edition 08/99
 USA.5102.04.21

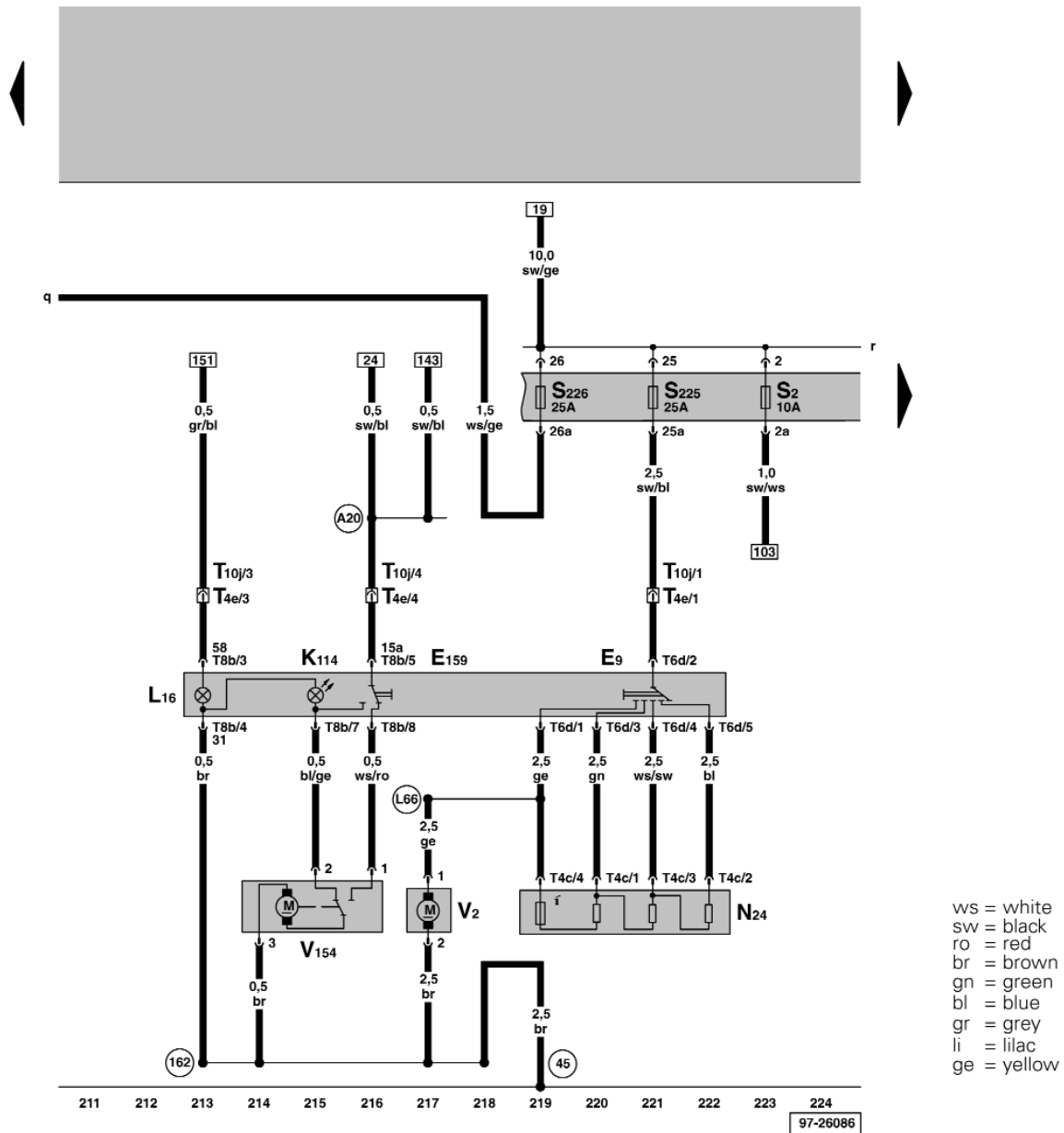

- E9 - Fresh Air Blower Switch
- E159 - Fresh Air/Recirculating Flap Switch
- K114 - Fresh Air and Recirculating Air Mode Indicator Light
- L16 - Fresh Air Control Lever Light
- N24 - Fresh Air Blower Series Resistance With Fuse
- S2 - Fuse 2 in fuse holder
- S225 - Fuse 25 in fuse holder
- S226 - Fuse 26 in fuse holder
- T4c - 4-Pin Connector
- T4e - 4-Pin Connector (in vehicles without air conditioning)
- T6d - 6-Pin Connector
- T8b - 8-Pin Connector
- T10j - 10-Pin Connector, behind instrument panel, center (in vehicles with air conditioning)

- V2 - Fresh Air Blower
- V154 - Servo motor for fresh-/recirculating air door
- (45) - Ground connection, behind instrument panel, center
- (162) - Ground connection, in blower motor wiring harness
- (A20) - Wire connection (15a), in instrument panel wiring harness
- (L66) - Connector, in wiring harness heater blower

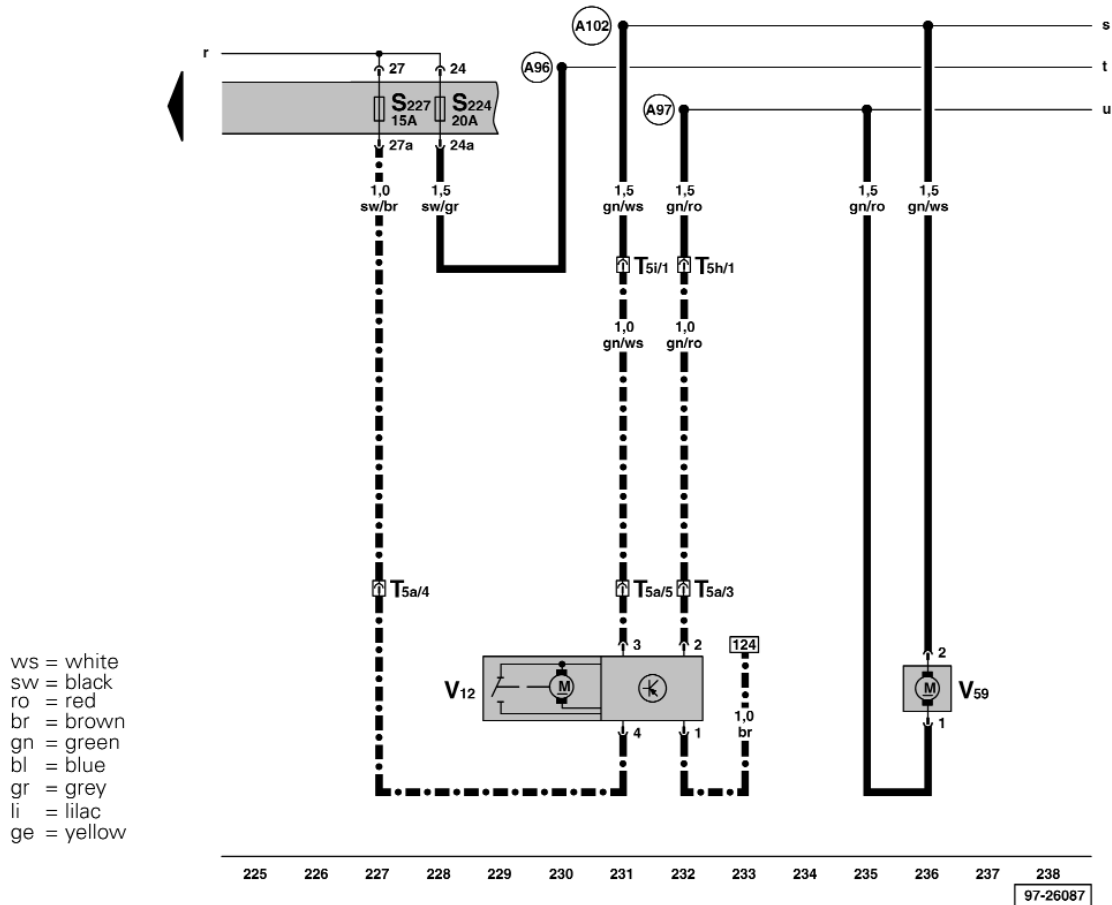

- S224 - Fuse 24 in fuse holder
- S227 - Fuse 27 in fuse holder
- T5a - 5-Pin Connector, pink, connector station C-pillar, left (Golf only)
- T5h - 5-Pin Connector, near left A-pillar, lower part, in harness
- T5i - 5-Pin Connector, near left A-pillar, lower part, in harness
- V12 - Motor for rear windshield wiper
- V59 - Windshield and Rear Window Washer Pump

- (A96) - Connector (53a), in instrument panel wiring harness
- (A97) - Connector (53), in instrument panel wiring harness

- (A102) - Connector (windshield wiper), in instrument panel wiring harness
- Golf only

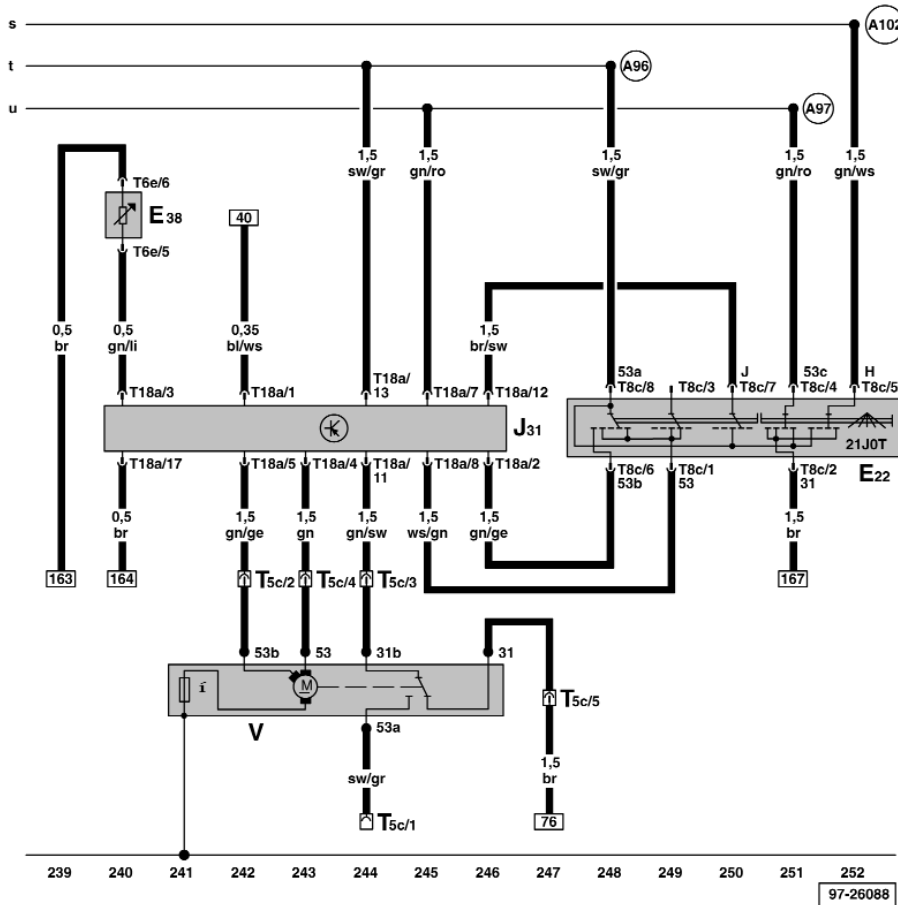

ws = white
 sw = black
 ro = red
 br = brown
 gn = green
 bl = blue
 gr = grey
 li = lilac
 ge = yellow

- E22 - Windshield Wiper/Washer Switch
- E38 - Windshield Wiper Intermittent Regulator
- J31 - Wiper/Washer Intermittent Relay, on relais panel
- T5c - 5-Pin Connector, on windshield wiper motor
- T6e - 6-Pin Connector
- T8c - 8-Pin Connector
- T18a - 18-Pin Connector
- V - Windshield Wiper Motor

- (A96) - Connector (53a), in instrument panel wiring harness
- (A97) - Connector (53), in instrument panel wiring harness
- (A102) - Connector (windshield wiper), in instrument panel wiring harness

Edition 08/99
 USA.5102.04.21

Windshield wiper/washer switch, windshield wiper intermittent regulator,
 windshield wiper motor, wiper/washer intermittent relay

Notes

1.8L - Engine - Motronic Multiport Fuel Injection (MFI)/110 kW, code AWD,

from November 1999

Deviate relay location and fuseplacements as well as the locations of multiple connectors see section "component locations".

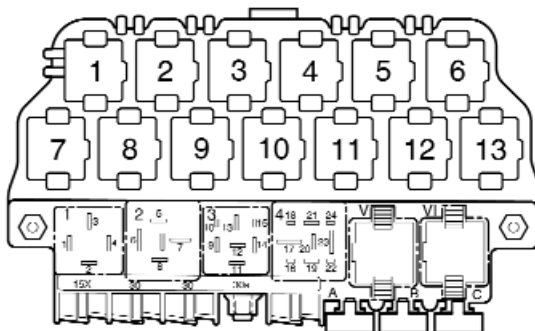

97-14163

Relay location on the thirteenfold auxiliary relay panel, above relay panel:

Relay panel:

- 2** Load Reduction Relay (100)
- 4** Fuel Pump (FP) Relay (109)

Note: Number in parentheses indicates production control number stamped on relay housing.

Fuse colors

- 30 A - green
- 25 A - white
- 20 A - yellow
- 15 A - blue
- 10 A - red
- 7.5 A - brown
- 5 A - beige
- 3 A - violet

Edition 12/00
USA.5102.09.21

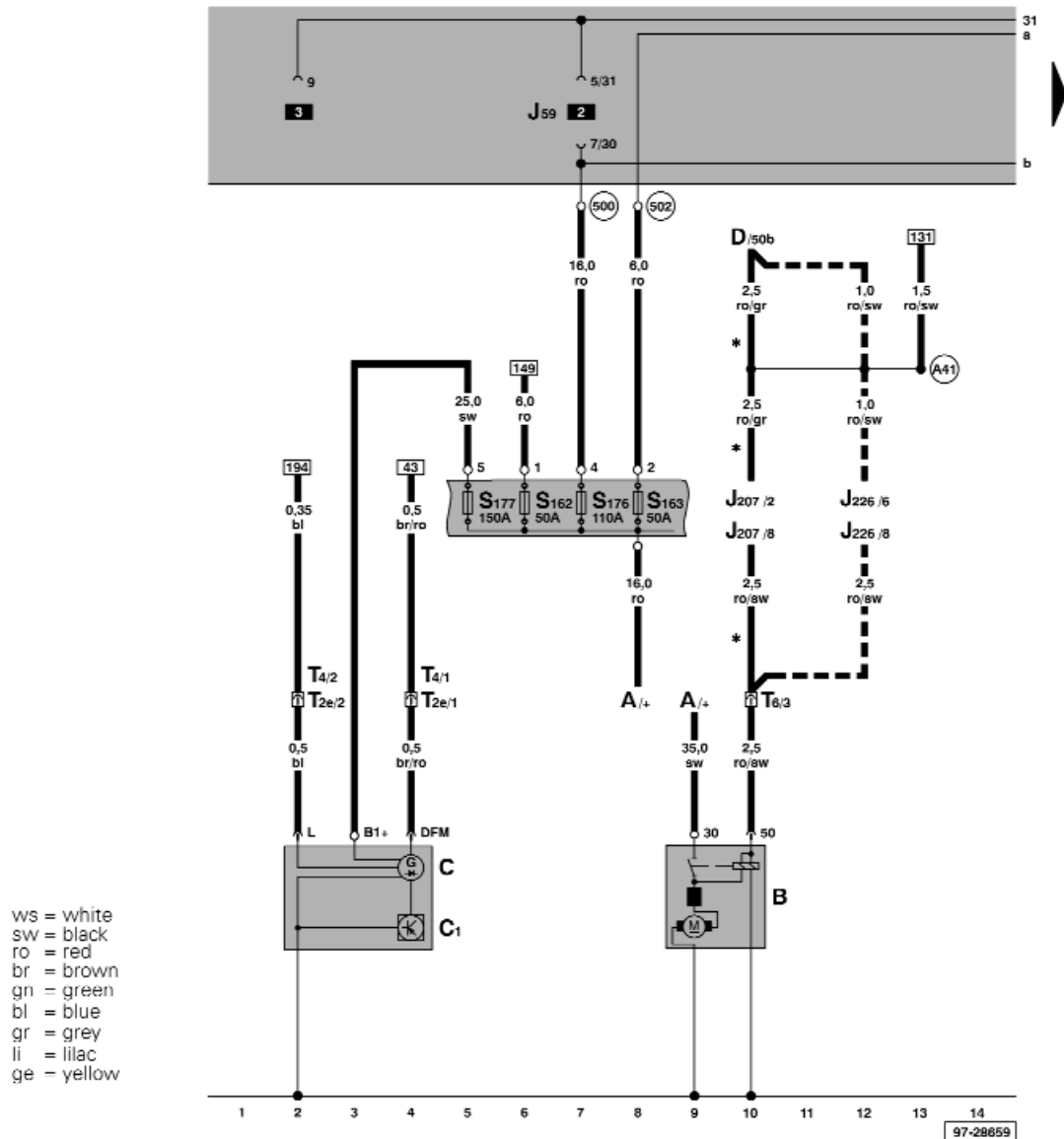

- A - Battery
- B - Starter
- C - Generator (GEN)
- C1 - Voltage Regulator (VR)
- D - Ignition/Starter Switch
- J59 - Load Reduction Relay
- J207 - Starting Interlock Relay
- J226 - Park/Neutral Position (PNP) Relay
- S162 - Fuse -1- (30) in fuse bracket/battery
- S163 - Fuse -2- (30) in fuse bracket/battery
- S176 - Fuse -4- (30) in fuse bracket/battery
- S177 - Fuse -5- (30) in fuse bracket/battery
- T2e - Double Connector, near starter (vehicles without air conditioning)
- T4 - 4-Pin Connector, near starter (vehicles with air conditioning only)

- T6 - 6 Pin Connector, brown, in protective housing for connectors, in plenum chamber, left
- (500) - Threaded connection -1- (30) on the relay plate
- (502) - Threaded connection -1- (30a) on the relay plate
- (A41) - Plus connection (50), in instrument panel wiring harness
- * - Manual transmission only
- Automatic transmission only

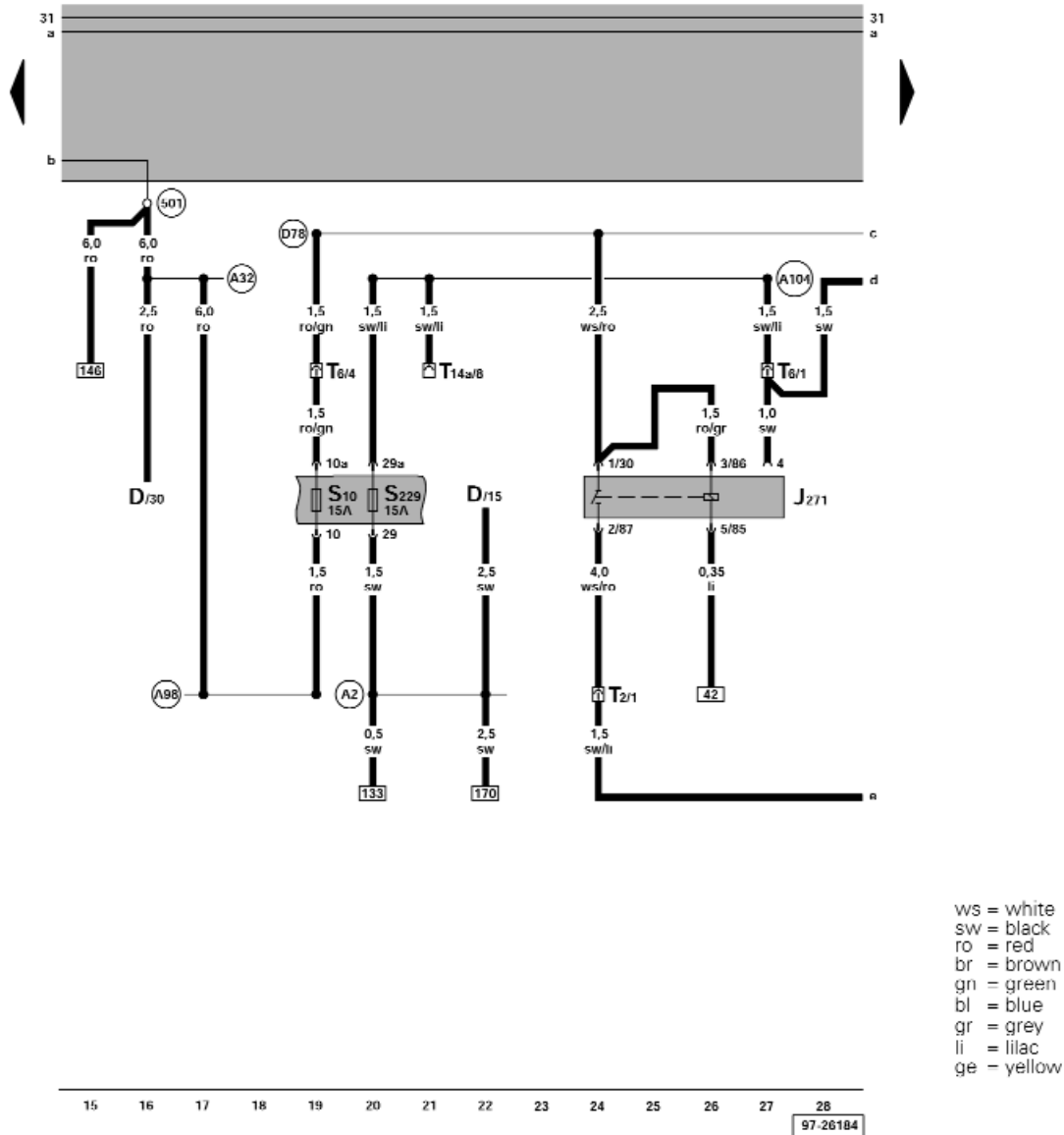

ws = white
 sw = black
 ro = red
 br = brown
 gn = green
 bl = blue
 gr = grey
 li = lilac
 ge = yellow

- D - Ignition/Starter Switch
- J271 - Motronic engine control module (ECM) power supply relay, in protective housing, in engine compartment, left, production control number (428)
- S10 - Fuse 10 in fuse holder
- S229 - Fuse 29 in fuse holder
- T2 - 2-Pin Connector, in engine compartment, left
- T6 - 6-Pin Connector, brown, in protective housing for connectors, in plenum chamber, left
- T14a - 14-Pin Connector, in engine compartment, in wiring duct, left
- (501) - Threaded connection -2- (30) on the relay plate

- (A2) - Plus connection (15), in instrument panel wiring harness
- (A32) - Plus connection (30), in instrument panel wiring harness
- (A98) - Plus connector -4- (30), in instrument panel wiring harness
- (A104) - Plus connector -2- (15), in instrument panel wiring harness
- (D78) - Plus connector -1- (30a), in engine compartment wiring harness

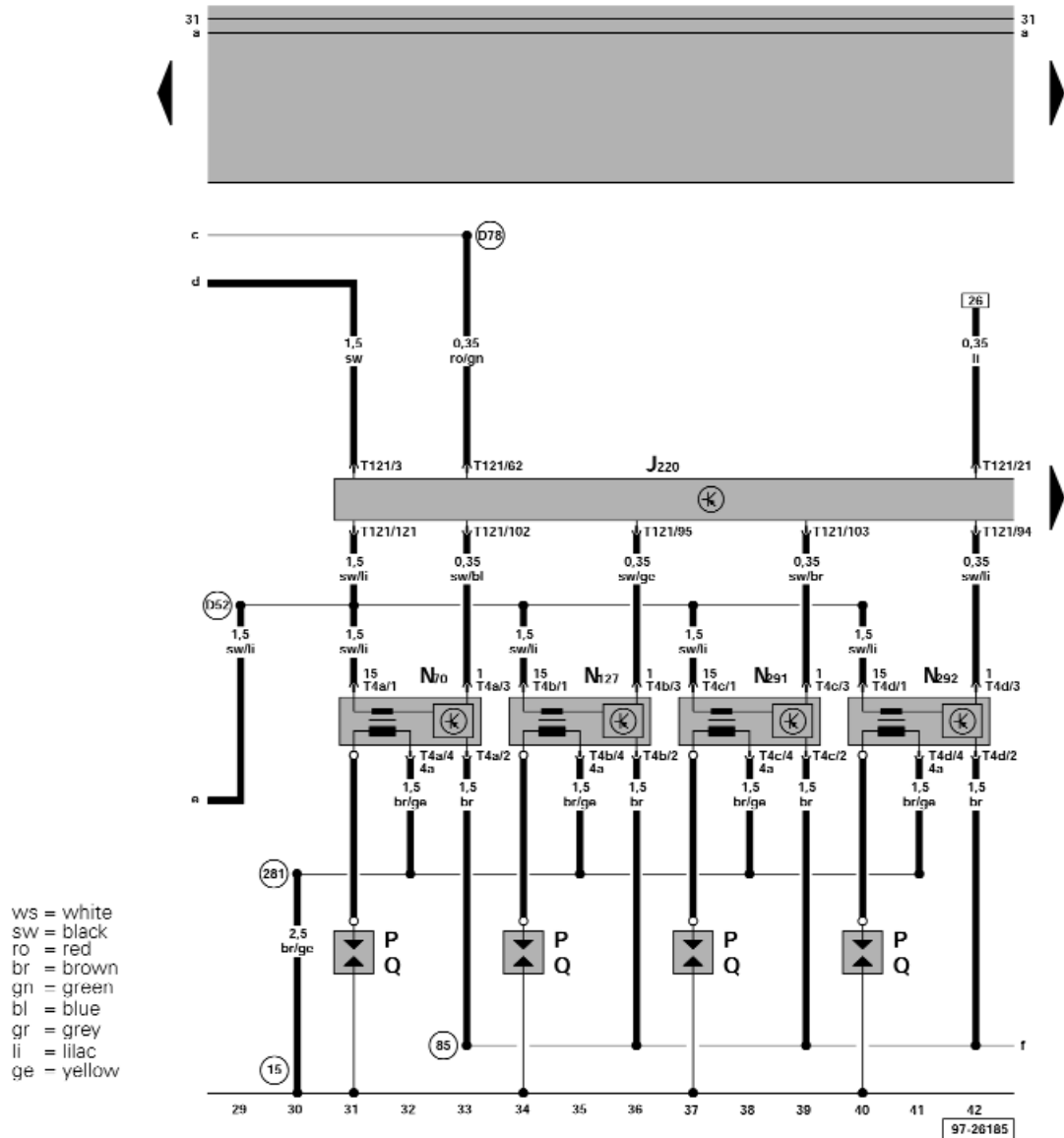

- J220 - Motronic Engine Control Module (ECM), in plenum chamber, center
- N70 - Ignition Coil 1 with Power Output Stage
- N127 - Ignition Coil 2 with Power Output Stage
- N291 - Ignition Coil 3 with Power Output Stage
- N292 - Ignition Coil 4 with Power Output Stage
- P - Spark Plug Connectors
- Q - Spark Plugs
- T4a - 4-Pin Connector
- T4b - 4-Pin Connector
- T4c - 4-Pin Connector
- T4d - 4-Pin Connector
- T121 - Connector, 121 point

- 85 - Ground connection -1-, in engine compartment wiring harness
- 281 - Ground connector -1-, in wiring harness engine pre-wiring
- D57 - Plus connector (15a), in engine compartment wiring harness
- D78 - Plus connector -1- (30a), in engine compartment wiring harness

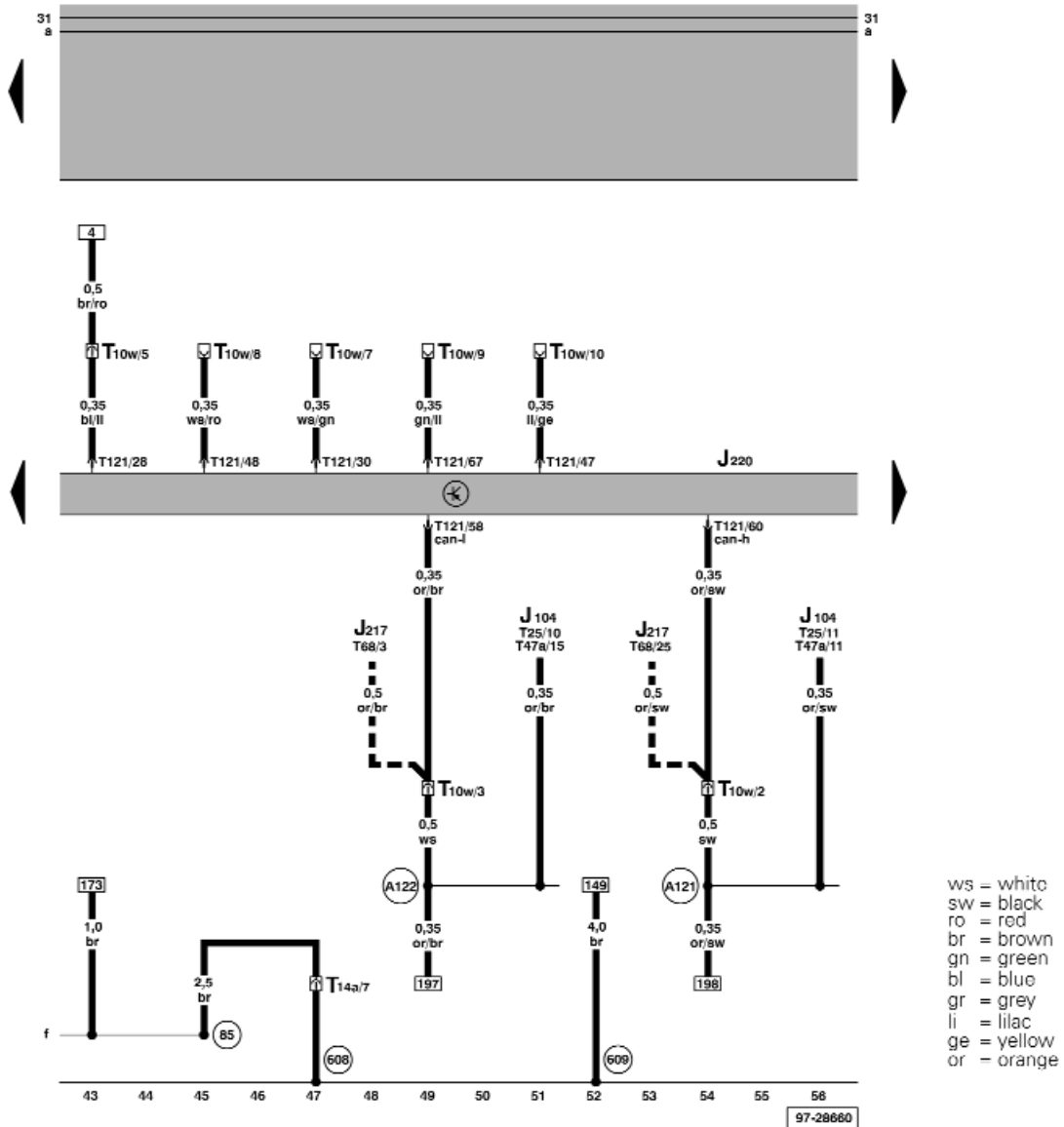

- J104 - ABS Control Module (w/EDL), in engine compartment, left
- J217 - Transmission Control Module (TCM), in plenum chamber, center
- J220 - Motronic Engine Control Module (ECM), in plenum chamber, center
- T10w- 10-Pin Connector, white, in protective housing for connectors, in plenum chamber, left
- T14a- 14-Pin Connector, in engine compartment, in wiring duct, left
- T25 - 25-Pin Connector, on ABS Control Module (through July 2000)
- T47a - 47-Pin Connector, on ABS Control Module (beginning August 2000)

- T68 - 68-Pin Connector, on Transmission Control Module (TCM)
- T121 - Connector, 121 point
- 85 - Ground connection -1-, in engine compartment wiring harness
- 608 - Ground Connection (in center plenum chamber)
- 609 - Ground Connection (in right plenum chamber)
- A121 - Connection (high bus), in instrument panel wiring harness
- A122 - Connection (low bus), in instrument panel wiring harness
- Automatic transmission only

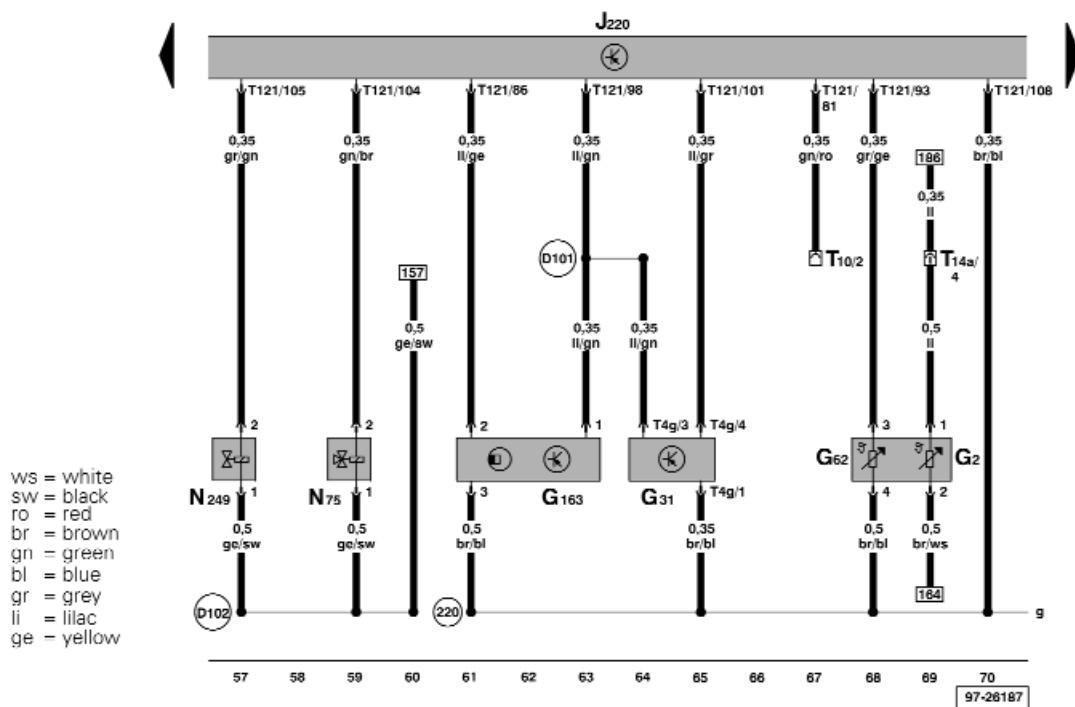

- G2 - Engine Coolant Temperature (ECT) Sensor
- G31 - Charge Air Pressure Sensor
- G62 - Engine Coolant Temperature (ECT) Sensor
- G163 - Camshaft Position (CMP) Sensor 2
- J220 - Motronic Engine Control Module (ECM), in plenum chamber, center
- N75 - Wastegate Bypass Regulator Valve
- N249 - Recirculating valve for turbocharger
- T4g - 4-Pin Connector
- T10 - 10-Pin Connector, orange, in protective housing for connectors, in plenum chamber, left
- T14a - 14-Pin Connector, in engine compartment, in wiring duct, left
- T121 - Connector, 121 point

- (220) - Ground connection (sensor ground), in engine compartment wiring harness
- (D101) - Wire connection -1-, in engine compartment wiring harness
- (D102) - Wire connection -2-, in engine compartment wiring harness

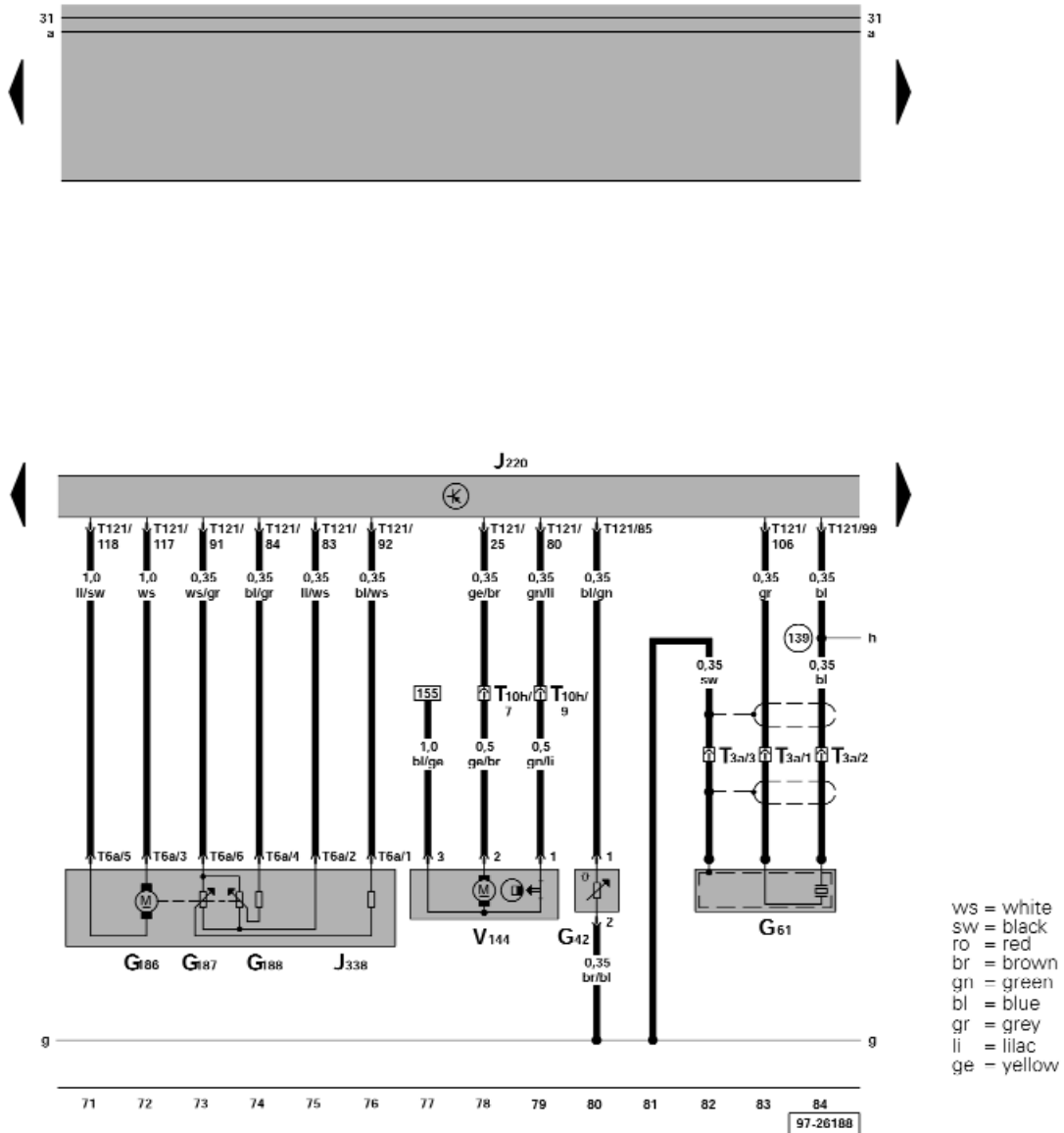

- G42 - Intake Air Temperature (IAT) Sensor
- G61 - Knock Sensor (KS) 1
- G186 - Throttle drive (power accelerator actuation)
- G187 - Angle sensor -1- for throttle drive (power accelerator actuation)
- G188 - Angle sensor -2- for throttle drive (power accelerator actuation)
- J220 - Motronic Engine Control Module (ECM), in plenum chamber, center
- J338 - Throttle Valve Control Module
- T3a - 3-Pin Connector, in engine compartment, front
- T6a - 6-Pin Connector
- T10h - 10 Pin Connector, blue, in protective housing for connectors, in plenum chamber, left
- T121 - Connector, 121 point
- V144 - Leak detection pump (LDP)
- (139) - Ground connection (sensor Ground), in Motronic Multipoint Fuel Injection (MFI) wiring harness

Edition 11/99 Motronic engine control module (ECM), angle sensor for throttle drive (power accelerator actuation), intake air temperature (IAT) sensor, knock sensor (KS) 1, leak detection pump (LDP)
 USA.5102.05.21

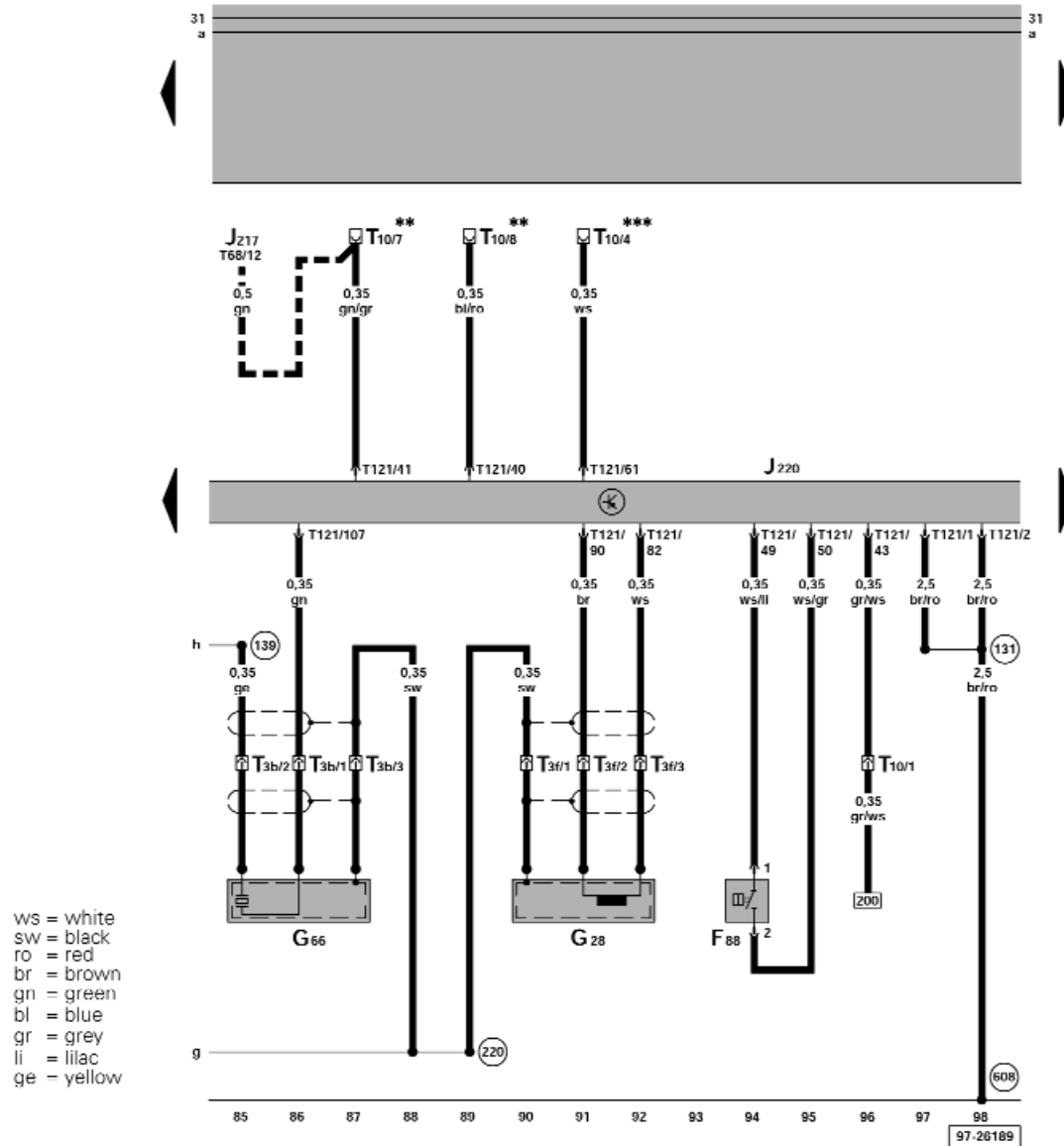

- F88 - Pressure switch/power steering
- G28 - Engine Speed (RPM) Sensor
- G66 - Knock Sensor (KS) 2
- J217 - Transmission Control Module (TCM), in plenum chamber, center
- J220 - Motronic Engine Control Module (ECM), in plenum chamber, center
- T3b - 3-Pin Connector, in engine compartment, front
- T3f - 3-Pin Connector, in engine compartment, front
- T10 - 10-Pin Connector, orange, in protective housing for connectors, in plenum chamber, left
- T68 - Connector, 68 point
- T121 - Connector, 121 point

- (139) - Ground connection (sensor Ground), in Motronic Multiport Fuel Injection (MFI) wiring harness
- (220) - Ground connection (sensor ground), in engine compartment wiring harness
- (608) - Ground Connection (in center plenum chamber)
- ** - A/C connection
- *** - Coolant Fan Control Module connection
- - Automatic transmission only

- (131) - Ground connection -2-, in engine compartment wiring harness

Motronic engine control module (ECM), pressure switch/power steering, engine speed (RPM) sensor, knock sensor (KS) 2

Edition 11/99
 USA.5102.05.21

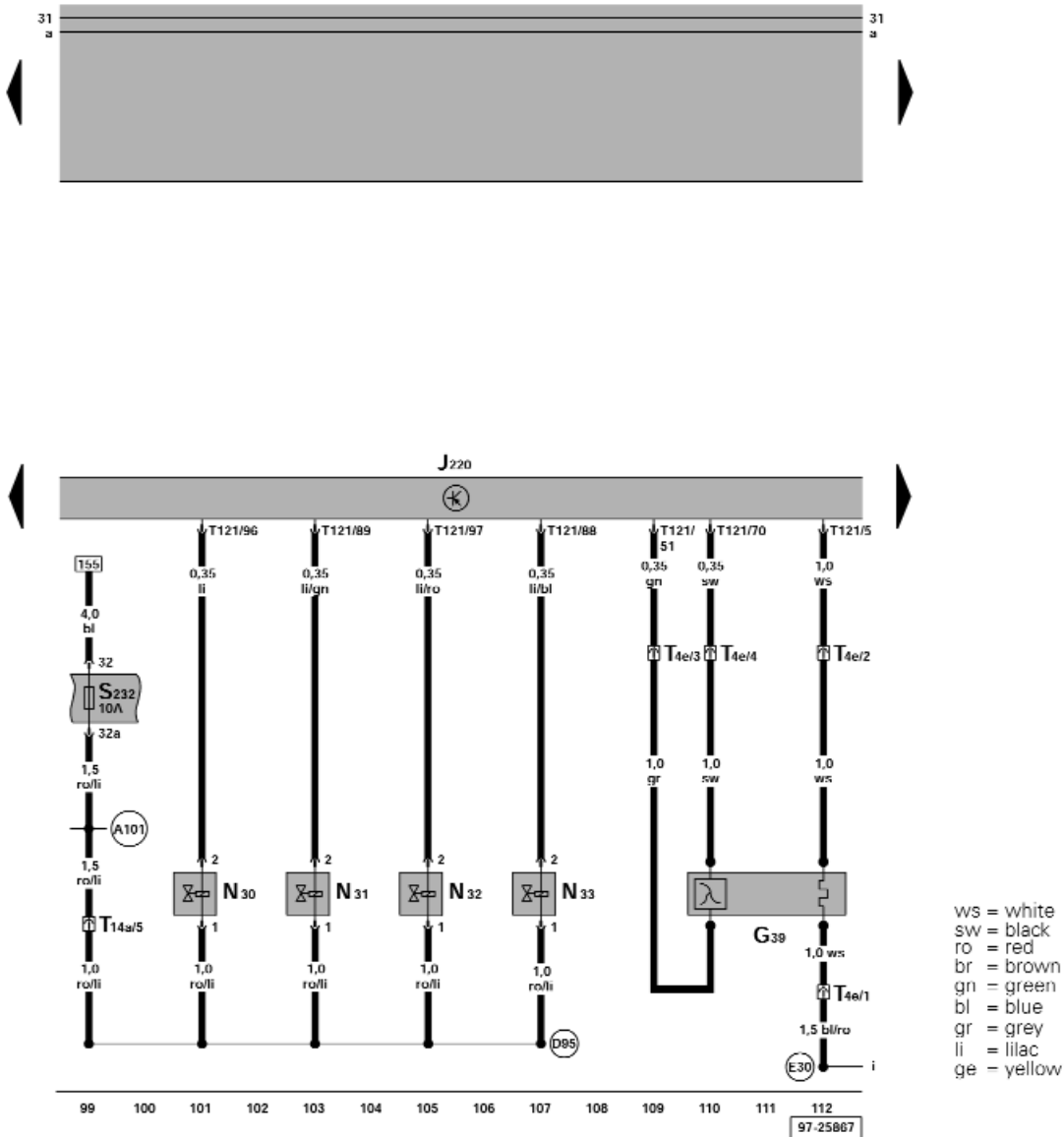

- G39 - Heated Oxygen Sensor (HO2S)
- J220 - Motronic Engine Control Module (ECM), in plenum chamber, center
- N30 - Cylinder 1 Fuel Injector
- N31 - Cylinder 2 Fuel Injector
- N32 - Cylinder 3 Fuel Injector
- N33 - Cylinder 4 Fuel Injector
- S232 - Fuse 32 in fuse holder
- T4e - 4-Pin Connector, in protective housing for connectors under right floor
- T14a - 14-Pin Connector, in engine compartment, in wiring duct, left
- T121 - Connector, 121 point
- (A101) - Connector -3- (87a), in instrument panel wiring harness

- (D95) - Wire connection (injectors), in engine compartment wiring harness
- (E30) - Connector (87a), in wiring harness engine

Edition 11/99
USA.5102.05.21

Motronic engine control module (ECM), heated oxygen sensor (HO2S), injectors

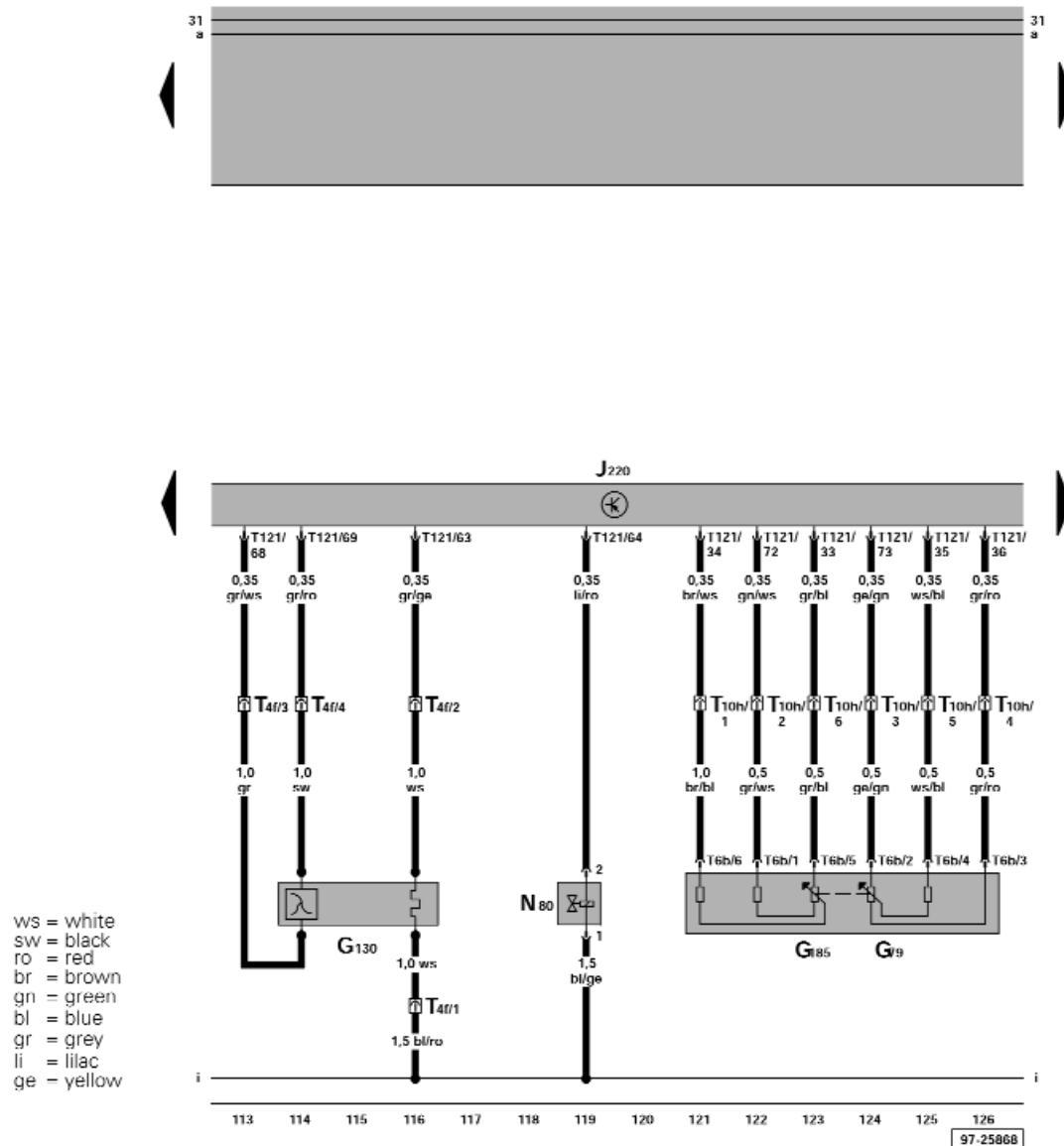

- G79 - Throttle Position (TP) Sensor
- G130 - Oxygen Sensor (O2S) behind Throc Way Catalytic Converter (TWC)
- G185 - Sender -2- for accelerator pedal position
- J220 - Motronic Engine Control Module (ECM), in plenum chamber, center
- N80 - Evaporative Emission (EVAP) Canister Purge Regulator Valve
- T4f - 4-Pin Connector, in protective housing for connectors under right floor
- T6b - 6-Pin Connector
- T10h - 10-Pin Connector, blue, in protective housing for connectors, in plenum chamber, left
- T121 - Connector, 121 point

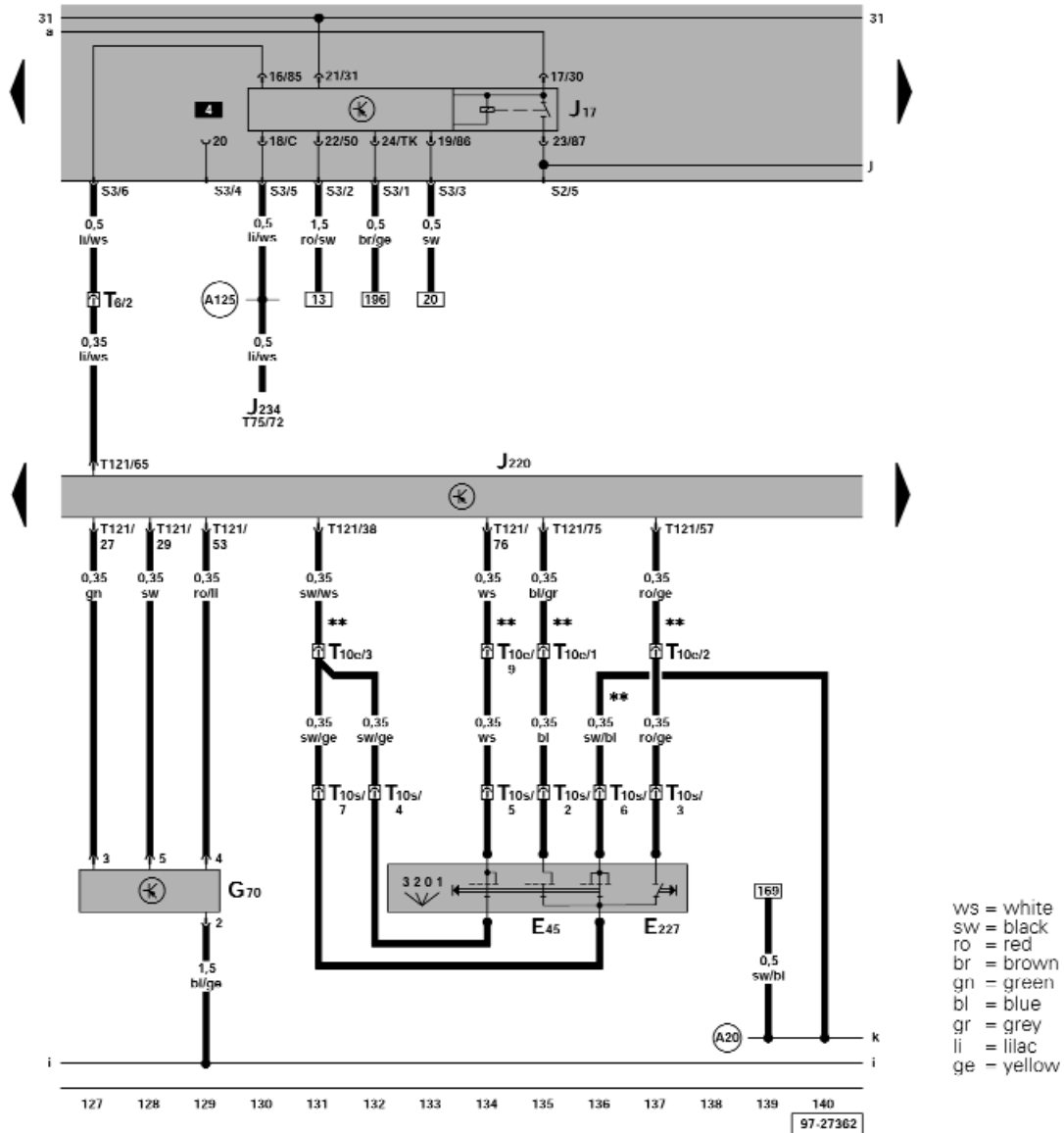

- E45 - Cruise Control Switch**
- E227 - Cruise Control Push Button (SET)**
- G70 - Mass Air Flow (MAF) Sensor
- J17 - Fuel Pump (FP) Relay
- J220 - Motronic Engine Control Module (ECM), in plenum chamber, center
- J234 - Airbag Control Module
- T6 - 6 Pin Connector, brown, in protective housing for connectors, in plenum chamber, left
- T10e - 10-Pin Connector, black, in protective housing for connectors, in plenum chamber, left
- T10s - 10-Pin Connector, near steering column
- T75 - 75-Pin Connector
- T121 - Connector, 121 point

- (A20) - Wire connection (15a), in instrument panel wiring harness
- (A125) - Connection (crash signal) in instrument panel wiring harness
- ** - Vehicles with cruise control only

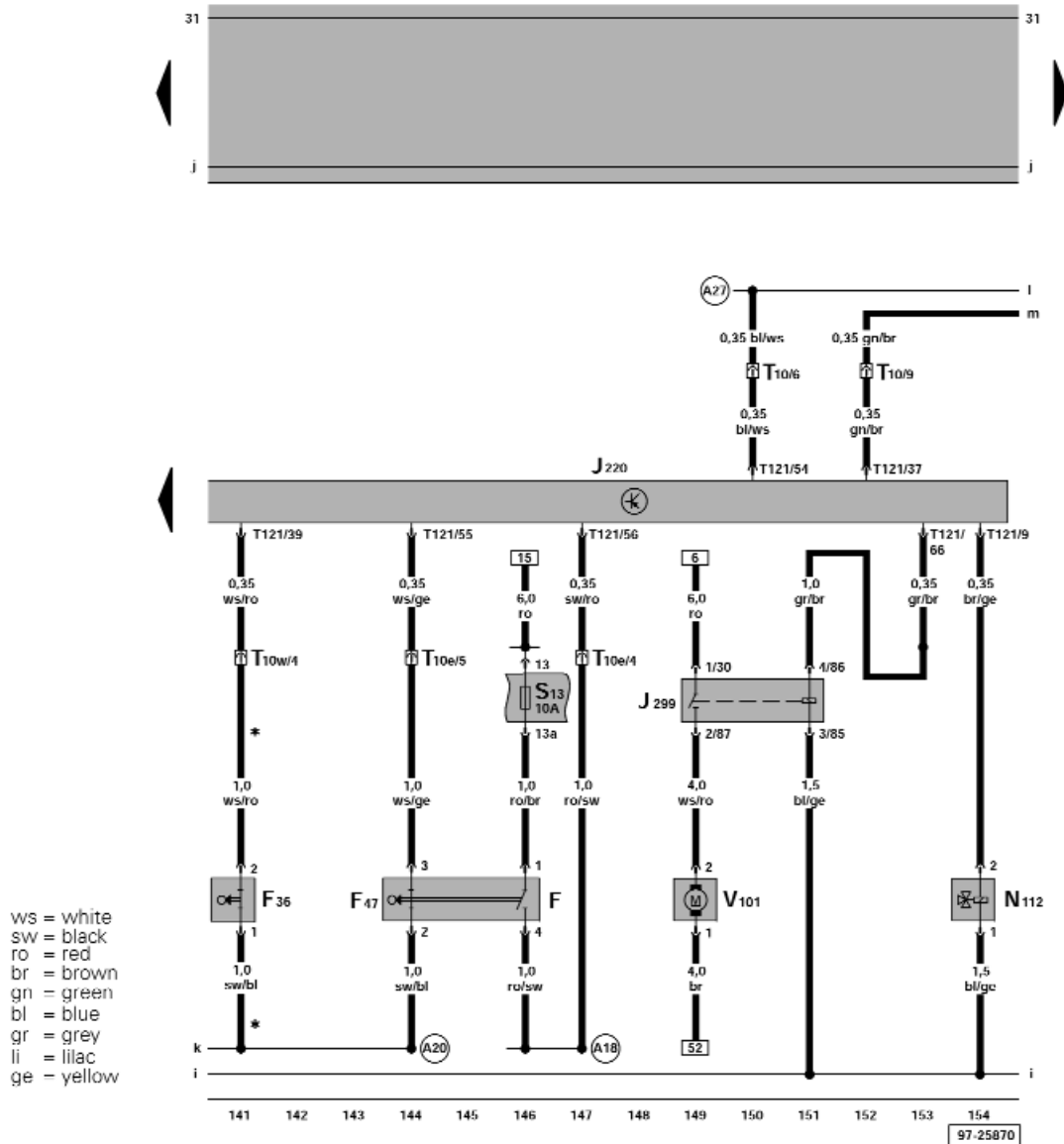

- F - Brake Light Switch
- F36 - Clutch Vacuum Vent Valve Switch
- F47 - Brake Vacuum Vent Valve Switch for cruise control
- J220 - Motronic Engine Control Module (ECM), in plenum chamber, center
- J299 - Secondary Air Injection (AIR) Pump Relay, in protective housing, in engine compartment, left, production control number (100)
- N112 - Secondary Air Injection (AIR) Solenoid Valve
- S13 - Fuse 13 in fuse holder
- T10 - 10-Pin Connector, orange, in protective housing for connectors, in plenum chamber, left
- T10e - 10-Pin Connector, black, in protective housing for connectors, in plenum chamber, left
- T10w - 10-Pin Connector, white, in protective housing for connectors, in plenum chamber, left
- T121 - Connector, 121 point
- V101 - Secondary Air Injection (AIR) Pump Motor

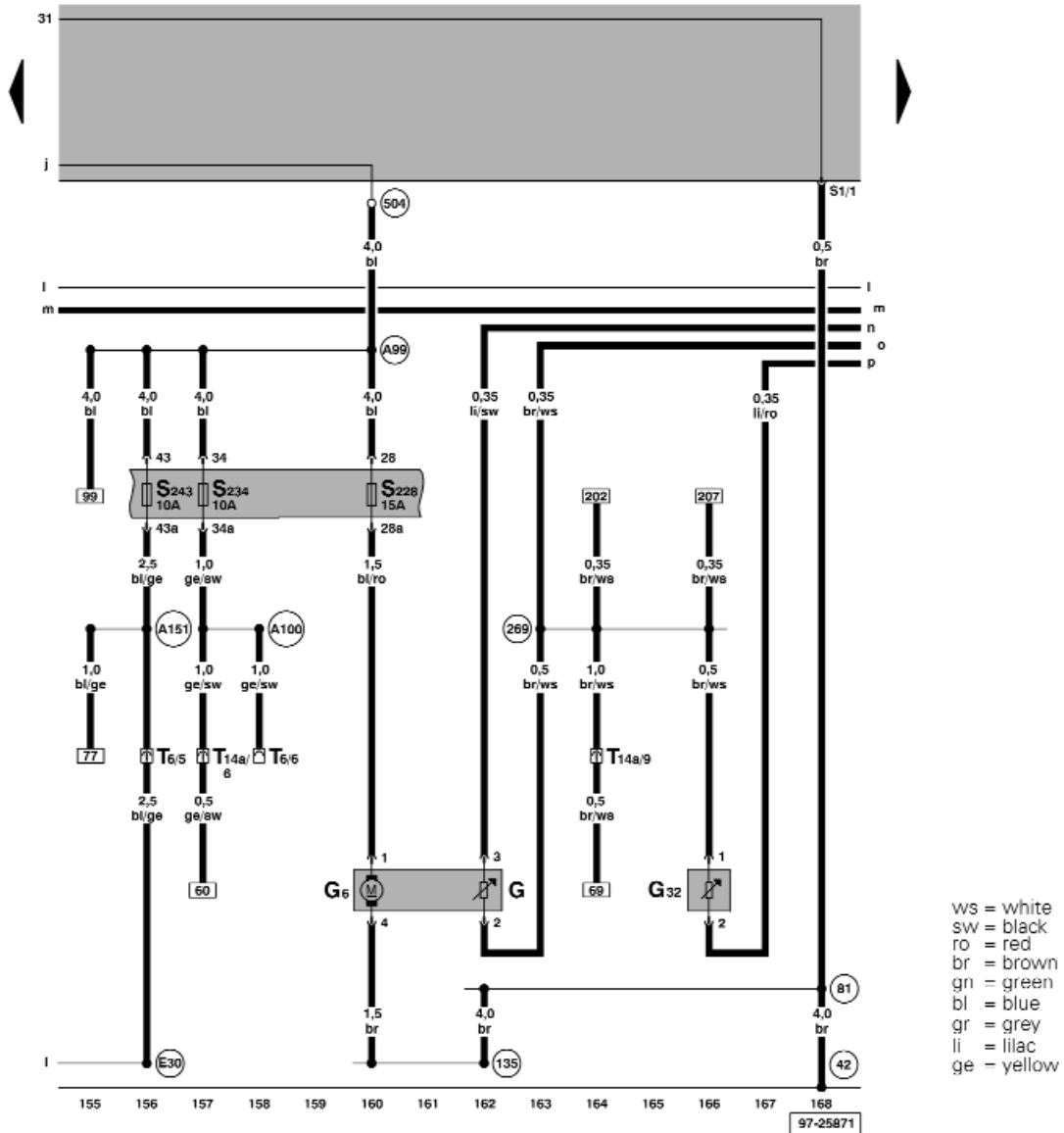

- G - Fuel Level Sensor
- G6 - Fuel Pump (FP)
- G32 - Engine Coolant Level (ECL) Sensor
- S228 - Fuse 28 in fuse holder
- S234 - Fuse 34 in fuse holder
- S243 - Fuse 43 in fuse holder
- T6 - 6-Pin Connector, brown, in protective housing for connectors, in plenum chamber, left
- T14a - 14-Pin Connector, in engine compartment, in wiring duct, left
- 42 - Ground connection, beside steering column
- 81 - Ground connection -1, in instrument panel wiring harness

- 135 - Ground connection 2, in instrument panel wiring harness
- 269 - Ground connection (sensor ground) -1, in instrument panel wiring harness
- 504 - Threaded connection -1- (87) on the relay plate
- A99 - Connector -1- (87), in instrument panel wiring harness
- A100 - Connector -2- (87), in instrument panel wiring harness
- A151 - Connector -4- (87), in instrument panel wiring harness
- E30 - Connector (87a), in wiring harness engine

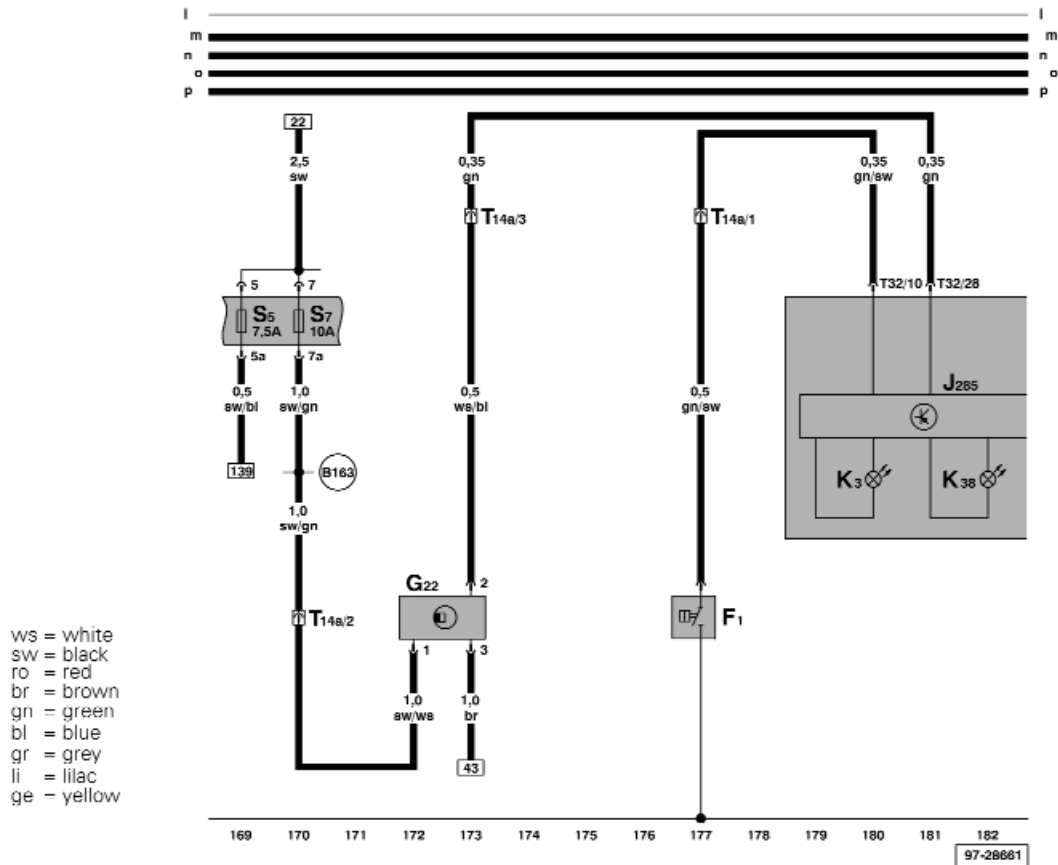

- F1 - Oil Pressure Switch
- G22 - Speedometer Vehicle Speed Sensor (VSS)
- J285 - Control module with indicator unit in instrument panel insert
- K3 - Oil Pressure Warning Light
- K38 - Engine Oil Level Indicator Light
- S5 - Fuse 5 in fuse holder
- S7 - Fuse 7 in fuse holder
- T14a - 14-Pin Connector, in engine compartment, in wiring duct, left
- T32 - 32-Pin Connector, blue
- (B163) - Plus connector -1- (15) in wiring harness interior

Instrument cluster, oil pressure switch, speedometer vehicle speed sensor (VSS), oil pressure warning light

Edition 12/00
 USA.5102.09.21

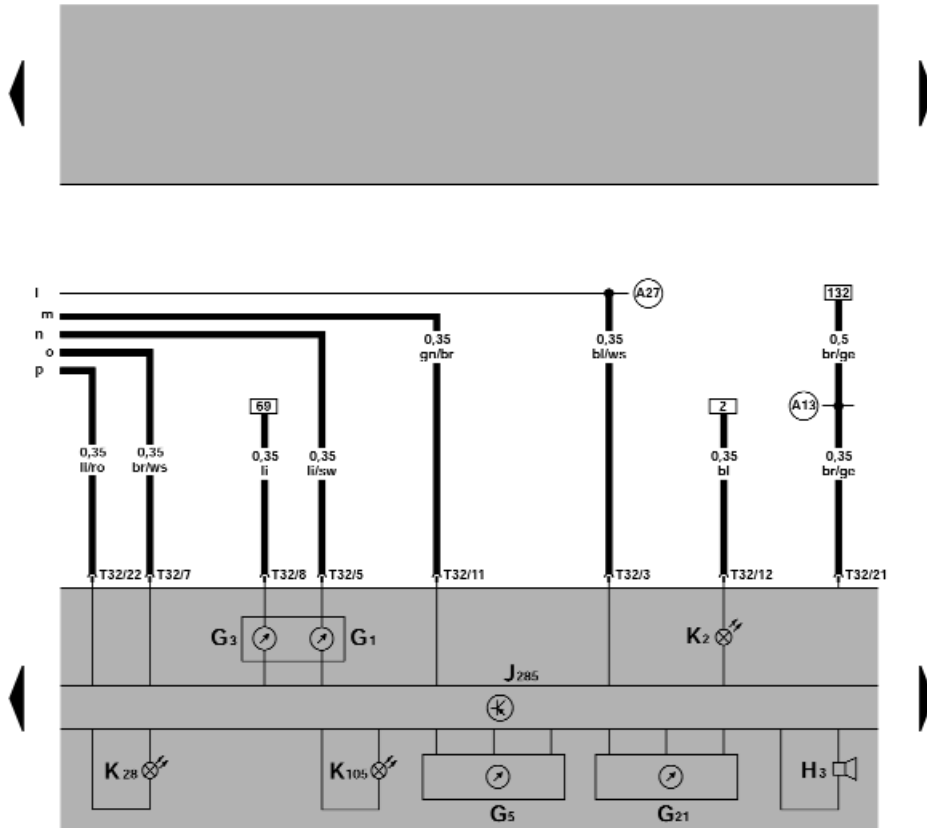

ws = white
 sw = black
 ro = red
 br = brown
 gn = green
 bl = blue
 gr = grey
 li = lilac
 ge = yellow

183 184 185 186 187 188 189 190 191 192 193 194 195 196
 97-26192

- G1 - Fuel gauge
- G3 - Engine Coolant Temperature (ECT) Gauge
- G5 - Tachometer
- G21 - Speedometer
- H3 - Warning Buzzer
- J285 - Control module with indicator unit in instrument panel insert
- K2 - Generator (GEN) Warning Light
- K28 - Engine Coolant Level/Temperature (ECL/ECT) Warning Light
- K105 - Low Fuel Level Warning Light
- T32 - 32-Pin Connector, blue
- (A13) - Wire connection (door contact switch), in instrument panel wiring harness
- (A27) - Wire Connection (vehicle speed signal), in instrument panel wiring harness

Edition 06/00
 USA.5102.06.21

Instrument cluster, engine coolant temperature (ECT) gauge, fuel gauge, tachometer, speedometer, generator (GEN) warning light

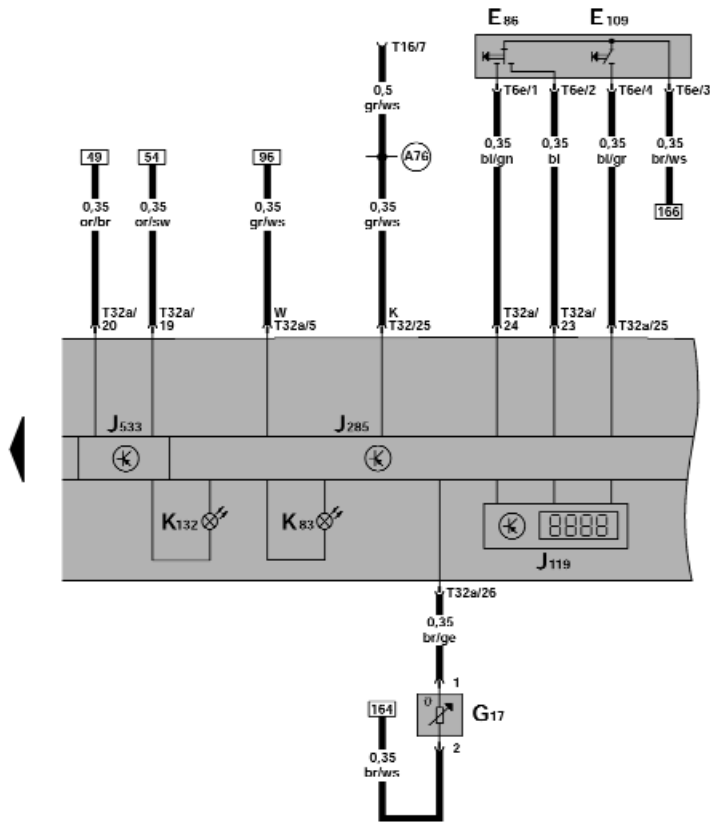

ws = white
 sw = black
 ro = red
 br = brown
 gn = green
 bl = blue
 gr = grey
 li = lilac
 ge = yellow
 or = orange

197 198 199 200 201 202 203 204 205 206 207 208 209 210
 97-28809

- E86 - Multi-Function Indicator Mode Select Switch
- E109 - Multi-Function Indicator Memory Switch
- G17 - Outside Air Temperature Sensor
- J119 - Multi-function Indicator (MFI)
- J285 - Control module with indicator unit in instrument panel insert
- J533 - Data Bus On Board Diagnostic Interface
- K83 - Malfunction Indicator Lamp (MIL)
- K132 - Electronic Power Control (EPC) Warning Lamp
- T6e - 6-Pin Connector
- T16 - Data Link Connector (DLC), below instrument panel, center
- T32 - 32-Pin Connector, blue
- T32a - 32-Pin Connector, green
- (A76) - Connector (K diagnosis wire), in instrument panel wiring harness

Instrument cluster, multi-function indicator (MFI), outside air temperature sensor, electronic power control (EPC) warning lamp

Edition 06/00
 USA.5102.06.21

Glossary

American Wire Gauge (AWG): The American standard for wire size, expressed in units from 2 gauge to 22 gauge.

Central relay panel: A centralized location for relays and circuits in an automobile. Includes common circuits used to provide battery power, ignition "ON", and Ground to vehicle systems.

Control Module: A transistorized, rather than analog, switching circuit that relies on one or inputs to control the switching of a logic circuit.

Current track number: A method of following circuits within Volkswagen wiring diagrams. The wiring diagram is numbered along the bottom of the page to aid in navigating between disconnected pages.

DIN (Deutsche Institut fur Normung) standards: German institute for standards that establishes guidelines for manufacturing and nomenclature.

Electric motor: A motor driven by electromotive force.

Fuse: A component installed in series with a circuit, designed to disrupt the circuit when carrying more than its specified amperage. Fuses are placed in circuits to protect other components in the circuit from damage.

Ground: A wire connected to the vehicle's chassis (and therefore the Ground). This allows power to be supplied by one insulated wire, while the chassis acts as the return path.

Internal conductors: Connections inside of a component, often not designated in the wiring diagrams.

Load reduction circuit: A circuit designed to switch off high current electrical consumers during starting to insure optimal available voltage supply to the starter. The term comes from removing the load of the consumers from the Ignition switch.

Metric wire sizes: The metric system for wire size, expressed in mm². This designates the cross-sectional area of the wire. The wiring used in Volkswagen vehicles ranges from .35 to 35 mm².

Multi-point connectors: A connector installed in a wiring harness that allows the wiring harness to be detached from the component.

Potentiometer: see Rheostat

Glossary

Relay: Component that uses a low current to switch a high current circuit.

Resistor: A component that creates a voltage drop in a circuit. Resistors can be used for measurement of current flow, as well as to drop the applied voltage for certain consumers.

Rheostat: A resistor that varies its resistance based on a mechanical input.

Push-on connectors: See Multi-point connector.

Solenoid: Used to actuate other components, a solenoid consists of a coil of wire wrapped around an iron core. When a current is passed through a wire, a magnetic field is induced. This magnetic "pull" is used to operate other components.

Switch: A component used to disrupt or redirect current flow.

Symbols: Graphical representations of electrical components in Volkswagen wiring diagrams

Temperature dependent resistor: A resistor that varies its resistance with temperature.

Threaded Connectors: A connector consisting of a threaded stud to which other wires attach. Often used in high Amperage circuits.

Vehicle Chassis: See Ground.

Welded Connectors: A connection inside of a component created by compressing several wires together under high heat, partially melting the separate wires together.

X circuit: See Load reduction circuit.

An on-line Knowledge Assessment (exam) is available for this
Self-Study Program

You can find this Knowledge Assessment on your
Certification Resource Center

at:

www.vwwebservice.com

From the vwwebservice.com homepage, do the following:

1. Click on the Certification tab
2. Click on "My Certification" tab
3. Click the Fulfill link next to this SSP
4. Click "Launch Assessment"

For assistance, please call:

Volkswagen Academy Concierge

1 – 877 – 791 – 4838

(8:00 a.m. to 8:00 p.m. EST)

Or, E-Mail:

concierge@volkswagenacademy.com

Volkswagen of America, Inc.
3800 Hamlin Road
Auburn Hills, MI 48326
Printed in U.S.A.
August 2001